

**Aqua Culture Sites**  
 <all other values>  
**Site\_Status**  
 Under Appeal  
 Application  
 Licensed

**Scale = 1:40,000**  
 Drawn : 12-12-2019

**BANTRY BAY AQUACULTURE SITES**

Ordnance Survey Ireland Licence No. EN 0076419  
 © Ordnance Survey Ireland/Government of Ireland



**An Roinn Talmhaíochta,  
 Bia agus Mara**  
 Department of Agriculture,  
 Food and the Marine

**An Roinn Talmhaíochta,  
Bia agus Mara**  
Department of Agriculture,  
Food and the Marine



19<sup>th</sup> December 2019

Your Refs: **AP32/2019 & AP49/2019**

Ms Mary O'Hara  
Secretary to the Board  
Aquaculture Licences Appeals Board  
Kilminchy Court  
Dublin Road  
Portlaoise  
Co. Laois

Dear Mary

I wish to acknowledge receipt of your letters dated 16<sup>th</sup> and 17<sup>th</sup> December 2019 to Mr. Michael Creed T.D., Minister for Agriculture, Food and the Marine (and copied to Mr. John Quinlan) which was received by the Department on the 18<sup>th</sup> December 2019, regarding the appeals against the decision to grant an Aquaculture Licence to West Cork Seafoods Ltd in relation to site **T05/430A** in Bantry Bay, Co. Cork.

I am attaching the following documentation:-

1. Copy of the submission to Minister, which includes the following documents;
  - Copy of the application form maps and drawings,
  - Copies of reports received in relation to the application,
  - Copy of the Screening Matrix for Aquaculture activities in Outer Bantry Bay,
  - Copies of the Draft Aquaculture and Foreshore Licences,
2. Copy of the notification of the Minister's decision to the applicant,
3. Copy of the applicant's reply to the public and statutory comments,
4. Location map of the surrounding area including the following:
  - Sites under application,
  - Licensed sites,
  - Sites currently under appeal (if any).

If you require anything further please let me know.

Yours Sincerely

**Maria Naughton**  
Aquaculture and Foreshore Division



24<sup>th</sup> October 2019

West Cork Seafoods Ltd,  
Dromleigh South,  
Bantry,  
Co Cork.

**Our Ref: T05/430 A & B**

**FISHERIES (AMENDMENT) ACT, 1997 (NO.23)**  
**NOTICE OF MINISTERIAL DECISION TO GRANT/REFUSE AQUACULTURE AND FORESHORE LICENCES**

Dear Sir,

I would like to inform you that the Minister for Agriculture, Food and the Marine has approved the granting to you of a 10-year Aquaculture Licence and accompanying Foreshore Licence, for the cultivation of mussels using longlines on site no. T05/430A (see attached information note.)

I would also like to inform you that the Minister for Agriculture, Food and the Marine has refused your application for an Aquaculture Licence and accompanying Foreshore Licence, for the cultivation of mussels using longlines site no. T05/430B, (see attached information note.)

I enclose a copy of the public notice of the decisions which **the Department** has arranged to have published in "The Southern Star".

Any person aggrieved by these decisions may, in accordance with Section 41 of the Fisheries (Amendment) Act 1997, appeal against them in writing to the Aquaculture Licences Appeals Board. This appeal must be lodged within one month beginning on the date of the publication of the decision.

In addition, a person may question the validity of the Foreshore Licence determinations by way of an application for judicial review, under Order 84 of the Rules of the Superior Court (SI No. 15 of 1986). Practical information on the review mechanism can be obtained from the Citizens Information Board at: <http://www.citizensinformation.ie/>

The Licences will be issued to you as soon as possible after the end of the period of one month from the date of publication of the notice in "The Southern Star", if there is no appeal.

Please also find enclosed the conditions that will apply to any Aquaculture Licence that may be issued by the Minister.

Yours sincerely

---

**Maria Naughton**  
**Aquaculture and Foreshore Management Division**

An Lárionad Bia Mara Náisiúnta, An Cloichín, Cloich na Coillte, Corcaigh, P85 TX47  
National Seafood Centre, Clogheen, Clonakilty, Co. Cork P85 TX47  
T +353 (0)23 8859521 maria.naughton@agriculture.gov.ie  
[www.agriculture.gov.ie](http://www.agriculture.gov.ie)

**S.12 (3) OF THE FISHERIES (AMENDMENT) ACT, 1997(NO.23)  
INFORMATION NOTE TO APPLICANT FOR THE PURPOSE OF REGULATION 18 OF THE  
AQUACULTURE (LICENCE APPLICATION) REGULATIONS 1998**

**REFERENCE NO:** T05/430A

**APPLICANT:** West Cork Seafoods Ltd,

**AQUACULTURE TO WHICH  
DECISION RELATES:** Cultivation of mussels using longlines on siteT05/430A on the  
foreshore in Bantry Bay, Co Cork.

**NATURE OF DECISION:** Grant of an Aquaculture Licence.

**DATE OF DECISION:** 21 October 2019

**CONDITIONS OF LICENCE:** See attached.

**DURATION OF LICENCE:** 10 years

**ISSUE OF LICENCE:** The licence will be dated and issued  
as soon as practicable after the end of the period of one month  
from the date of publication of a notice in a newspaper  
circulating in the vicinity of the aquaculture, if no appeal is made  
to the Aquaculture Licences Appeals Board within that period,  
under Section 40 and 41 of the Fisheries (Amendment) Act, 1997.

**Note:** It has been decided to grant the applicant a separate Foreshore Licence under the Foreshore Act, 1933 (No.12), contemporaneous with the Aquaculture Licence, subject to standard conditions applicable to Foreshore Licences.

**S.12 (3) OF THE FISHERIES (AMENDMENT) ACT, 1997(NO.23)  
INFORMATION NOTE TO APPLICANT FOR THE PURPOSE OF REGULATION 18 OF THE  
AQUACULTURE (LICENCE APPLICATION) REGULATIONS 1998**

**REFERENCE NO:** T05/430B

**APPLICANT:** West Cork Seafoods Ltd,

**AQUACULTURE TO WHICH  
DECISION RELATES:** Cultivation of mussels using longlines on site T05/430B on the  
foreshore in Bantry Bay, Co. Cork

**NATURE OF DECISION:** Refusal of an Aquaculture Licence.

**DATE OF DECISION:** 21 October 2019

**REASON FOR REFUSAL:**

The Minister for Agriculture, Food and the Marine has determined that it is not in the public interest to grant the licences sought. In making his determination the Minister considered those matters which by virtue of the Fisheries (Amendment) Act 1997, and other relevant legislation, he was required to have regard. Such matters include any submissions and observations received in accordance with the statutory provisions. *In particular, the Minister had regard to the findings of the Commissioner of Irish Lights and the site's location relative to anchorage number four in Bantry Bay.* The following is the reason and consideration for the Minister's determination to refuse the licence sought:

- The site is considered too close to Bantry Bay anchorage number four. Therefore a vessel anchored within the extremities of the anchorage could encroach onto the site whilst swinging at anchor.

To be inserted in “The Southern Star”.

**FISHERIES (AMENDMENT) ACT, 1997 (NO. 23) FORESHORE ACT, 1933 (NO. 12)  
NOTICE OF DECISION TO GRANT/REFUSE AQUACULTURE AND FORESHORE  
LICENCES.**

The Minister for Agriculture, Food and the Marine has decided to grant/refuse Aquaculture and Foreshore Licences to the following applicants for sites in Bantry Bay, Co. Cork:

Site Ref	Applicant	Location	Species & Cultivation	Grant/ Refuse
[REDACTED]	[REDACTED]	[REDACTED]	[REDACTED]	[REDACTED]
[REDACTED]	[REDACTED]	[REDACTED]	[REDACTED]	[REDACTED]
T05/430A	West Cork Seafoods Ltd	Glanlough along the south shore of Bantry Bay	Mussels using longlines	Grant
T05/430B	West Cork Seafoods Ltd	Glanlough along the south shore of Bantry Bay	Mussels using longlines	Refuse
[REDACTED]	[REDACTED]	[REDACTED]	[REDACTED]	[REDACTED]
[REDACTED]	[REDACTED]	[REDACTED]	[REDACTED]	[REDACTED]
[REDACTED]	[REDACTED]	[REDACTED]	[REDACTED]	[REDACTED]
[REDACTED]	[REDACTED]	[REDACTED]	[REDACTED]	[REDACTED]
[REDACTED]	[REDACTED]	[REDACTED]	[REDACTED]	[REDACTED]

The reasons for these decisions are elaborated on the Department’s website at:

<http://www.agriculture.gov.ie/seafood/aquacultureforeshoremanagement/aquaculturelicensing/aquaculturelicencedecisions/>

An appeal against the Aquaculture Licence decisions may be made in writing, within one month of the date of its publication, to THE AQUACULTURE LICENCES APPEALS BOARD, Kilminchy Court, Portlaoise, Co. Laois, by completing the Notice of Appeal Application Form available from the Board, phone 057 86 31912, e-mail [info@alab.ie](mailto:info@alab.ie) or website at <http://www.alab.ie/>

A person may question the validity of the Foreshore Licence determinations by way of an application for judicial review, under Order 84 of the Rules of the Superior Court (SI No. 15 of 1986). Practical information on the review mechanism can be obtained from the Citizens Information Board at: <http://www.citizensinformation.ie/>



## West Cork Seafoods.

Harbour View House,  
Wolf Tone Square,  
Bantry, Co Cork.

22/05/2019

Dear Theresa O Keeffe

Re; Application from West Cork Seafoods Ltd. for Aquaculture Licences 2 sites in Bantry Bay T05/430A & T05/430B.

I wish to acknowledge receipt of your letters dated 1<sup>st</sup> & 2<sup>nd</sup> of May 2019, which included observations & objections to the proposed development from Statutory and public submissions.

I have read and noted each submission and will comment as follows;

1. Marine Institute;

We note that the Marine Institute do not object to the granting of this license, as outlined, "Both sites T05/430A & T05/430B are located within the Bantry Bay South designated Shellfish Growing Area",

" Considering the location nature and scale of the proposed aquaculture activity, the Marine Institute is of the view, that there will be no significant impact on the marine environment and that the quality status of the area will not be adversely impacted"

The sites are not within a Natura 2000 Site

We have noted the other comments & observations stated by the Marine institute and the applicant will observe and comply with same.

The source of the stock for these sites will be natural spat collections, thinning's & onward growing

2. Sea Fisheries Protection Authority (SFPA)

We note that the SFPA do not object to the granting of this license application,

We have noted their comments and subject to the licence being granted as operators, we will cooperate fully with the SFPA in facilitating access to the site in order to obtain samples for the Classification, Shellsan and Biotoxin monitoring programs.

3. Commissioner of Irish Lights

Site T05/430A We note that the Commissioner of Irish Lights have no objection to the development, "Provided that no navigable inter-tidal channels are impeded by the site"

That the applicant secures Statutory Sanction from the Commission of Irish Lights for the aids to navigation that may be required by the Marine Survey office.

That the size and specification of aids to navigation should be of the design and specification approved by the Marine Survey Office and must be agreed in advance with the Commissioners of Irish Lights.

It is Recommended that local fishing and leisure interests be consulted prior to a decision being made.

If a license is granted, the UK Hydrographic Office at Taunton must be informed of the developments geographical position in order to update nautical charts and other publications.



Site T05/430B, we note that the Commissioner for Irish Lights has objected to this site based on the consideration that this site is too close to Bantry Bay anchorage number four.

There are four such anchorage sites in Bantry Bay, which I understand are .40NM in size, originally designated for Tanker Moorings. Presently there is limited Tanker traffic compared to the busy times of Gulf Oil with weekly tanker movement in the bay, the prevailing winds in Bantry Bay are from a west south west direction, the site T05/430B is situated .30NM from the nearest Anchorage circle, also the wind would have to be in a north westerly direction to swing a vessel from Anchorage number four in the direction of the site.

4. Inshore Fishermen and [REDACTED]

Mussel Farming commenced in Bantry Bay in 1982 and inshore fishing is still a livelihood for many in the area, if anything the fishing of potted shrimp and swimming crab has increased as a result of the mussel lines giving significant shelter and food to these species. Starfish are a concern as a predator to both the mussel farmer and the in shore fisherman

5. There is a considerable number of objections from residents of the local community;

I have read through all of these objections and noted their contents.

There are a number of concerns mentioned by the objectors but these for the most part are not in breach of legislative regulations, and would have been taken into consideration when the south shore was designated as "Shellfish Growing Waters".

Bantry Bay is a magnificent natural bay and my family for over four generations have lived in Bantry, but Bantry Bay is also a commercial bay with Cruse Liners, Tanker Traffic, the country's reserve oil storage depot on Whiddy Island, Sailing, Small Craft Hire, Aquaculture of Mussels and Algae commercially grown, the fishing port of Castletownbere and also smaller inshore fishing activities

It must be noted, that following the Tanker Disaster at Whiddy Island Jan 1979 and the clean up which took nearly three years. In 1982 mussels, being filter feeders were placed on various locations in the bay to analyse the Hydro Carbon content in the water.

From these trials it was noted the accelerated growth, quality and meat content in the mussels was significant, unemployment was at all-time high, so Mussel Farming was proposed as a possible solution. Aquaculture and the processing of its product, is now possibly the largest employer in the Bantry area of West Cork with two factories employing in excess of 100 personnel whose products from Bantry Bay are now exported across the four continents worldwide, plus the Bantry Marine Research Station, employing a further 13 people, these employees numbers feed many families in the local community. It must also be noted that one of the best selling item in the restaurant's is local rope grown Mussels.

Aquaculture is a sustainable method of producing healthy nutritional food to assist in feeding the world's growing population and is the only certain way to increase employment in our coastal areas.

I trust you will take the aforementioned into consideration when making your decision on our application for both sites T05/430A & T05/430B and hopefully get a positive result

Yours Sincerely  
Gareth Murphy  
West Cork Seafoods

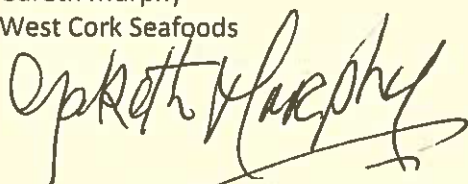

# Submission AGR 00572 -19: Recommendation to grant an Aquaculture Licence (T05/430A)

TO: Minister  
STATUS: Completed  
PURPOSE: For Decision

AUTHOR: Naughton, Maria  
OWNER: Naughton, Maria  
REVIEWERS: O'Keeffe, Therese  
Horan, Helena  
Quinlan, John  
Beamish, Cecil  
Smith, Ann

DIVISION: Coastal Zone Management  
DECISION BY:

## Final comment

Minister determines the Aquaculture and Foreshore Licences sought be granted for the reasons outlined.

## Action required

Ministerial Determination on Aquaculture/Foreshore Licensing Application (T05/430A)

## Executive summary

The Minister's determination is requested in relation to an application of an Aquaculture Licence from West Cork Seafoods Ltd, Dromleigh South, Bantry, Co Cork. The application is for the culture of mussels using longlines in relation to a 24.2029 hectare site on an area of foreshore at Glanlough along the south shore of Bantry Bay, Co. Cork.

A submission in respect of the application for the Foreshore Licence is also set out for the Minister's consideration.

It is recommended that the Minister determines the Aquaculture and Foreshore Licences sought be granted to West Cork Seafoods Ltd, Dromleigh South, Bantry, Co Cork for the reasons outlined in the 'Detailed Information' section below.

**Note: Tabs attached to this submission may contain additional information which is subject to redaction if transmitted to third parties.**

## Detailed information

### Detail Information

#### DECISION SOUGHT

The Minister's determination is requested in relation to an application of an Aquaculture Licence from West Cork Seafoods Ltd, Dromleigh South, Bantry, Co Cork. The application is for the cultivation of mussels using longlines in relation to a 24.2029 hectare site on an area of foreshore at Glanlough along the south shore of Bantry Bay, Co. Cork. A submission in respect of the application for the Foreshore Licence is also set out for the Minister's consideration.

#### BACKGROUND

Marine aquaculture operations require separate Aquaculture and Foreshore Licences and Ministerial approval is requested in respect of this submission (Aquaculture Submission) and the submission underneath (Foreshore Submission), which refer to the same site.

The Aquaculture Licence defines the activity that is permitted on a particular site and the Foreshore Licence allows for the occupation of that particular area of foreshore. The continuing validity of each licence is contingent on the other licence remaining in force.

## APPLICATION FOR AN AQUACULTURE LICENCE

An application for an Aquaculture Licence has been received from the applicant referred to above (in conjunction with an application for a Foreshore Licence), for the cultivation of mussels using longlines in relation to a 24.2029 hectare site on an area of foreshore at Glanlough along the south shore of Bantry Bay, Co. Cork (numbered T05/430A – see documents at **TAB A**).

## LEGISLATION

Section 7 of the Fisheries (Amendment) Act 1997 provides that the licensing authority (i.e. Minister, delegated officer or, on appeal, the Aquaculture Licences Appeals Board) may, if satisfied that it is in the public interest to do so, licence a person to engage in aquaculture.

## CONSULTATION AND PUBLIC COMMENT

The application was sent to the Department's technical experts, statutory consultees and was also publicly advertised in a composite public notice covering both aquaculture and foreshore elements.

### Technical Consultation – (see documents at **TAB B**)

**Marine Engineering Division (MED):** MED have no objection to the licensing of this site and recommend conditions in the licence regarding the site layout.

**Sea Fisheries Protection Authority (SFPA):** SFPA state that the site appears to be located directly over potting and scallop dredging ground. The site is located within an area which is not classified for production of mussels, therefore if the licence is granted a sampling regime as required under the SFPA Code of Practice for the Microbiological Monitoring of Bivalve Mollusc Production Areas would have to be undertaken prior to the harvesting of mussels.

**Marine Survey Office (MSO):** No comment received from the MSO

It is proposed to insert a specific condition covering MSO matters in any licence/s which may issue as follows:

*The Minister's determination in respect of this licence is conditional upon immediate full compliance by the Licensee in respect of all requirements and conditions which are imposed under the relevant legal provisions applicable to the Marine Survey Office.*

### Statutory Consultation – (see documents at **TAB C**)

Regulation 10 of the Aquaculture (Licence Application) Regulations, 1998 requires certain statutory bodies to be notified of an Aquaculture Licence application.

Comments were received from the following statutory bodies:

**Marine Institute (MI):** No objection to the application.

The MI made the following recommendations:

- MI recommends that the initial source of seed and other sources which may be used at any point in the future should be approved by the Minister. This approval should be a specific condition of any licence that may issue.
- Prior to the commencement of operations at the site, the applicant be required to draw up a contingency plan, for the approval of DAFM, which shall identify, inter alia, methods for the removal from the environment of any invasive non-native species introduced as a result of operations at this site. If such an event occurs, the contingency plan shall be implemented immediately.

Following considerations implicit to Sections 61 (e and f) of the Fisheries (Amendment) Act 1997, the Marine Institute is of the view that there will be no significant impacts on the marine environment and that the quality status of the area will not be adversely impacted.

Following a request for information from AFMD to MI on the effect of licensing the site on commercial fishing, MI's report summary is as follows:

"In summary there is likely to be some overlap between the licence applications and shrimp, lobster, crab and perhaps scallop fisheries and therefore some loss of fishing ground. This loss is small relative to the total area of fishing ground available but there is also incremental and cumulative loss in fishing ground as each individual aquaculture licence application is granted".

**Commissioner of Irish Lights (CIL):** CIL has no objection to this licence and recommends that if the licence is granted that all structures must be clearly marked as required by Regulations and Licensing Permit conditions and to the approval of the Nautical Surveyor with the Marine Survey Office.

### **Public Consultation**

The application was publicly advertised using a composite public notice covering both aquaculture and foreshore elements, in The Southern Star on 30 March, 2019. The application and supporting documentation were available for inspection at Bantry Garda Station for a period of 4 weeks from the date of publication of the notice in the newspaper.

There were 30 objections received from the public consultation process. It is not possible to disaggregate the comments into aquaculture and foreshore elements.

The objections can be summarised as follows:

Negative impact on tourism based businesses, visual impact, inshore fishing, pollution, detrimental effect on the ecology of the bay, restrict access to moorings, other users of the bay including water sports, degradation of the foreshore environment, site exposed to prevailing winds, possibility of damage to the equipment on site during storms, micro plastics.

A copy of all the observations/submissions received at the Public/Statutory consultation stage was forwarded to the applicant.

The applicant responded by noting the comments from the MI, SFPA and CIL.

The applicant also noted the comments from the objectors and inshore fishermen and refutes their claims.

### **CRITERIA IN MAKING LICENSING DECISIONS**

The licensing authority, in considering an application, is required by statute to take account of, as appropriate, the following points and must also be satisfied that it is in the public interest to license a person to engage in aquaculture:

a) The suitability of the place or waters

Scientific advice is to the effect that the waters are suitable for the cultivation of mussels.

b) other beneficial uses of the waters concerned

Public access to recreational and other activities cannot be accommodated by this project;

c) the particular statutory status of the waters

(i) Natura 2000

The proposed site is located in Bantry Bay, which is not a Natura 2000 area. However, it is adjacent to a number of Natura sites. A screening matrix was carried out by our scientific advisors who considered that there will be no significant effects on the qualifying interests of the Natura sites (See documents at **Tab D**);

(ii) Shellfish Waters

The site is located within the Bantry Bay South Shellfish Designated Waters.

The mussels are not currently classified in this part of Bantry Bay;

d) the likely effects on the economy of the area

Aquaculture has the potential to provide a range of benefits to the local community, such as attraction of investment capital, development of support services, etc.

e) the likely ecological effects on wild fisheries, natural habitats, flora and fauna

No significant issues arose regarding wild fisheries;

f) the effect on the environment generally

The Department's Scientific Advisors, the Marine Institute, are of the view that there will be no significant impacts on the marine environment and that the quality status of the area will not be adversely impacted.

## RECOMMENDATION

It is recommended that the Minister:

approves the granting of an Aquaculture Licence (see documents at **TAB E**) to West Cork Seafoods Ltd, Dromleigh South, Bantry, Co Cork, for a period of ten (10) years for the purpose of cultivating mussels using longlines in accordance with the terms and conditions of the attached draft Aquaculture Licence.

## REASONS FOR DECISION

The Minister for Agriculture, Food and the Marine is required to give public notice of both the licensing determination and the reasons for it. To accommodate this, it is proposed to publish the following on the Department's website, subject to the Minister approving the above recommendation:

### "Determination of Aquaculture/ Foreshore Licensing application –T05/430A

West Cork Seafoods Ltd, Dromleigh South, Bantry, Co Cork has applied for authorisation to cultivate mussels using longlines on the sub-tidal foreshore on a 24.2029 hectare site (T05/430A) at Glanlough along the south shore of Bantry Bay, Co. Cork.

The Minister for Agriculture, Food and the Marine has determined that it is in public interest to grant the licence sought. In making his determination the Minister considered those matters which by virtue of the Fisheries (Amendment) Act 1997, and other relevant legislation, he was required to have regard. Such matters include any submissions and observations received in accordance with the statutory provisions. The following are the reasons and considerations for the Minister's determination to grant the licence sought:

- a. *Scientific advice is to the effect that the waters are suitable;*
- b. *Public access to recreational and other activities can be accommodated by this project;*
- c. *The proposed development should have a positive effect on the economy of the local area;*
- d. *All issues raised during Public and Statutory consultation phase were given consideration and addressed as necessary;*
- e. *The possible effects on the man-made environment heritage of value in the area have been taken into consideration;*
- f. *No significant effects arise regarding wild fisheries;*
- g. *The proposed aquaculture activities do not spatially overlap with Natura 2000 sites and there should be no significant impacts on the nearest Natura site(s).*
- h. *There are no significant impacts on the marine environment and the quality status of the area will not be adversely impacted;*
- i. *The updated Aquaculture and Foreshore licences contain terms and conditions which reflect the environmental protection now required under EU and National law."*

### Recommendation to grant a Foreshore Licence application (T05/430A)

#### DECISION SOUGHT

The Minister's determination is requested please in relation to the application for a Foreshore Licence from West Cork Seafoods Ltd, Dromleigh South, Bantry, Co Cork, for a site at Glanlough along the south shore of Bantry Bay, Co. Cork, in which it is proposed to conduct aquaculture.

#### BACKGROUND

Marine aquaculture operations require separate Aquaculture and Foreshore Licences and Ministerial approval is requested in respect of this submission (Foreshore Submission) and the submission above (Aquaculture Submission), which refer to the same site.

The Foreshore Licence allows for the occupation of the particular area of foreshore while the Aquaculture Licence defines the activity that is permitted in this area. The continuing validity of each licence is contingent on the other licence remaining in force.

## **APPLICATION FOR A FORESHORE LICENCE**

An application (**TAB A**) for a Foreshore Licence has been received from the applicant referred to above (in conjunction with an Aquaculture Licence application), relating to the occupation of the foreshore associated with the Aquaculture Licence application which covers a 24.2029 hectare site (numbered T05/430A).

## **LEGISLATION**

Section 3 of the Foreshore Act, 1933 gives power to the Minister to licence the use of foreshore, if he is of the opinion that it is in the public interest to do so.

## **CONSULTATION AND PUBLIC COMMENT**

The application was sent to the Department's technical experts, and was also publicly advertised in a composite public notice covering both aquaculture and foreshore elements.

This application was also sent to the Department of Housing, Planning and Local Government (DHPLG) in accordance with subsection (1B) of Section 3 of the Foreshore Act, 1933, which requires consultation between the Minister for Agriculture, Food and the Marine and the Minister for Housing, Planning and Local Government. Whilst aquaculture legislation requires certain statutory bodies to be notified of an aquaculture application, no other statutory bodies are prescribed consultees under Fisheries related foreshore legislation.

**DHPLG** There were no comments received from a water quality or foreshore perspective.

### **Technical Consultation – (see documents at TAB B)**

**Marine Engineering Division (MED):** MED have no objection to the licensing of this site and recommend conditions in the licence regarding the site layout.

**Sea Fisheries Protection Authority (SFPA):** SFPA state that the site appears to be located directly over potting and scallop dredging ground. The site is located within an area which is not classified for production of mussels, therefore if the licence is granted a sampling regime as required under the SFPA Code of Practice for the Microbiological Monitoring of Bivalve Mollusc Production Areas would have to be undertaken prior to the harvesting of mussels.

**Marine Survey Office (MSO):** No comment received from the MSO

It is proposed to insert a specific condition covering MSO matters in any licence/s which may issue as follows:

*The Minister's determination in respect of this licence is conditional upon immediate full compliance by the Licensee in respect of all requirements and conditions which are imposed under the relevant legal provisions applicable to the Marine Survey Office.*

### **Public Consultation**

The application was publicly advertised using a composite public notice covering both aquaculture and foreshore elements, in The Southern Star on 30 March, 2019. The application and supporting documentation were available for inspection at Bantry Garda Station for a period of 4 weeks from the date of publication of the notice in the newspaper.

There were 30 objections received from the public consultation process. It is not possible to disaggregate the comments into aquaculture and foreshore elements.

The objections can be summarised as follows:

Negative impact on tourism based businesses, visual impact, inshore fishing, pollution, detrimental effect on the ecology of the bay, restrict access to moorings, other users of the bay including water sports, degradation of the foreshore environment, site exposed to prevailing winds, possibility of damage to the equipment on site during storms, micro plastics.

## CRITERIA IN MAKING LICENSING DECISIONS

The Minister, in considering an application for a Foreshore Licence, may, if satisfied that it is in the public interest to do so, grant such a licence.

Section 82 of the Fisheries (Amendment) Act, 1997 stipulates that the Minister, in considering an application for a licence under the Foreshore Acts, which is sought in connection with the carrying on of aquaculture pursuant to an Aquaculture Licence, shall have regard to any decision of the licensing authority in relation to the Aquaculture Licence.

## RECOMMENDATION

It is recommended that the Minister:

approves the granting of a Foreshore Licence (see documents at **TAB F**) to West Cork Seafoods Ltd, Dromleigh South, Bantry, Co Cork, for a site at Glanlough along the south shore of Bantry Bay, Co. Cork, for a period of ten (10) years for occupation of the site for the carrying out of aquaculture activities as defined in the Aquaculture Licence, and in accordance with the terms and conditions of the attached draft Foreshore Licence.

## Related submissions

There are no related submissions.

## Comments

**O'Keefe, Therese** - 10/10/2019 15:36

Recommended that the Minister grants the Aquaculture and Foreshore licences for the reasons outlined in the submission.

**Horan, Helena** - 11/10/2019 14:16

I agree with the recommendation that the Minister determines that the Aquaculture and Foreshore licences sought for this site be granted for the reasons outlined.

**Quinlan, John** - 14/10/2019 09:47

Recommended for approval please.

**Beamish, Cecil** - 18/10/2019 10:49

Recommended that the Minister determines the Aquaculture and Foreshore Licences sought be granted for the reasons outlined in the submission.

**Smith, Ann** - 18/10/2019 10:50

Approved for submission to Minister. AS 18/10/2019

**Lennox, Graham** - 21/10/2019 16:22

Minister determines the Aquaculture and Foreshore Licences sought be granted for the reasons outlined.

## User details

INVOLVED: Naughton, Maria  
O'Keefe, Therese  
Horan, Helena  
Quinlan, John  
Beamish, Cecil  
Sub Sec Gens Office

READ RECEIPT: Naughton, Maria  
O'Keefe, Therese  
Horan, Helena  
Quinlan, John  
Beamish, Cecil  
Smith, Ann

eSub Sec Gen  
eSub Ministers Office  
eSub Minister

Lennox, Graham



TOS/430 A



**AQUACULTURE - LICENSING UNDER**  
**FISHERIES (AMENDMENT) ACT 1997 as amended**  
**and**  
**FORESHORE ACT 1933 as amended**

*Application Form for an Aquaculture and Foreshore Licence for  
a single specific site.*  
*If a Licence is required for more than one site a separate  
application form must be completed for each site.*

**Important Note**

Section 4 of the Fisheries and Foreshore (Amendment) Act, 1998 (No. 54 of 1998) prohibits any person making an application for an Aquaculture Licence from commencing aquaculture operations until duly licensed under the Fisheries (Amendment) Act, 1997 (No. 23 of 1997), and provides that a breach of that prohibition will cause the application to fail.

A copy of an Environmental Impact Statement and Natura Impact Statement should be enclosed, if required, with all new, review and renewal applications. See Guidance Notes Section 3.

Aquaculture & Foreshore Management Division,  
Department of Agriculture, Food and the Marine,  
National Seafood Centre,  
Clonakilty, Co. Cork  
Telephone: (023) 8859500  
Fax: (023) 8821782

Revised 2014

AQUACULTURE AND FORESHORE LICENCE APPLICATION FORM, for purposes of  
FISHERIES (AMENDMENT) ACT, 1997 and FORESHORE ACT, 1933

**NB: The accompanying Guidance Notes should be read before completing this form.**

**Note:** Details provided in Parts 1 and 2 will be made available for public inspection. Details provided in Parts 3 and 4 and any other information supplied will not be released except as may be required by law, including the Freedom of Information Act 1997 as amended.

**USE BLOCK CAPITALS IN BLACK INK PLEASE**

For Office Use

Application Ref. No. T5 490A

Date of Receipt (Dept. Stamp):

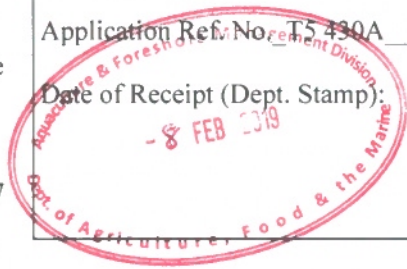

Type of Applicant (tick one)		
Sole Trader		<input type="checkbox"/>
Partnership		<input type="checkbox"/>
Company		<input checked="" type="checkbox"/>
Co-Operative		<input type="checkbox"/>
Other	Please specify-	<input type="checkbox"/>

**PART 1: PRELIMINARY DETAILS**

Applicant's Name(s)
1. West Cork Seafoods Ltd
Address: Drom Leigh South, Bantry, Co. Cork
2.
Address:
3.
Address:
4.
Address:

<b>Contact in case of enquiries (if different from above)</b>	
Contact Name	[REDACTED]
Organisation Name (if applicable)	[REDACTED]
Address	[REDACTED]

**PART 1: PRELIMINARY DETAILS**

**TYPE OF APPLICATION** – please indicate relevant type of application  
This Application Form is valid for each type of application - *See Guidance Note 3.1*

(i) Aquaculture Licence	<input checked="" type="checkbox"/>
(ii) Trial Licence	<input type="checkbox"/>
(iii) Foreshore Licence, if Marine Based	<input checked="" type="checkbox"/>
(iv) Review of Aquaculture Licence	<input type="checkbox"/>
(v) Renewal of Aquaculture Licence	<input type="checkbox"/>

**TYPE OF AQUACULTURE** *See Guidance Note 3.2*

Indicate the relevant type of application with a tick.

(i) **MARINE-BASED**

Finfish	<input type="checkbox"/>	Go to Parts 2.1 and 2.1A
Shellfish <i>Subtidal</i>	<input checked="" type="checkbox"/>	Go to Parts 2.2 and 2.2A
<i>Intertidal</i>	<input type="checkbox"/>	Go to Parts 2.2 and 2.2A
Seaweed/Aquatic Plants/Aquatic Fish Food	<input type="checkbox"/>	Go to Parts 2.3 and 2.3A

(ii) **LAND-BASED**

Finfish	<input type="checkbox"/>	Shellfish	<input type="checkbox"/>	Go to Parts 2.4 and 2.4A
Aquatic Plants	<input type="checkbox"/>	Aquatic Fish Food	<input type="checkbox"/>	Go to Parts 2.4 and 2.4A

## 2.2 MARINE-BASED SHELLFISH AQUACULTURE

When filling out this section refer also to 2.2A and Guidance Note 3.3 for information on Conditions and Documents required with this application type

### Proposed Site Location

- (i) Bay: \_\_\_\_\_ Bantry Bay \_\_\_\_\_
- (ii) County: \_\_\_\_\_ Cork \_\_\_\_\_
- (iii) OS Map No: \_\_\_\_\_ 84 \_\_\_\_\_
- (iv) Co-ordinates of Site: (please specify coordinate reference system used e.g. Irish Grid (IG) or Irish Transverse Mercator (ITM) or Latitude/Longitude [in which case specify whether ETRS89 or WG84 etc.]
- |         |          |
|---------|----------|
| Easting | Northing |
| 87460   | 44050    |
| 88040   | 44260    |
| 88170   | 43900    |
| 87600   | 43680    |
- (v) Size of Site (hectares): \_\_\_\_\_ 24.2 \_\_\_\_\_

(vi) Species (common and scientific name) and whether native or non-native species: (see Guidance Notes 3.3.1)

**Blue Mussel – *Mytilus edulis***

(vii) Whether production will be sub-tidal or inter-tidal?

**Subtidal**

(viii) Please supply details of (a) source of seed e.g. wild hatchery and location and (b) means of collection and introduction to culture.

**Natural Collection on ropes**

NB Importation of seed into the State or movement of seed within the State requires notification to the Marine Institute as per the Fish Health Authorisation Regulations – See Guidance Notes Section 6

(ix) Method of culture (rope, trestles – intensive; bottom – extensive; other) \_\_\_\_\_

**220m subsurface longline**

(x) Proposed number of lines/ropes/trestles as per site layout drawing

**10 x 220m**

(xi) Proposed Production Tonnage:

Year 1		Year 2	140	Year 3	140	Year 4	140	Year 5	140
--------	--	--------	-----	--------	-----	--------	-----	--------	-----

(xii) (a) Please outline the reasons for site selection:

**Expansion of operations, offshore mussel farming, space, good quality water, nutrients, close to processing factories**

---

(b) If using trestles please outline the physical characteristics of the site which make it suitable for using trestles

---

---

(xiii) Is it intended that the product is for direct human consumption or half grown? Please specify

**Direct human consumption \_**

(xiv) How will the visual impact issues of the flotation devices for the proposed application be addressed?

**Sub surface longlines, grey barrels, uniform lines**

(xv) Is the site located in Designated Shellfish Waters Area? (Refer to Guidance Note 3.3.2)

Yes  No

If **yes** give details.

**Bantry Bay South**

---

If **no** outline the reasons why you believe the site suitable for the proposed aquaculture, notwithstanding its location outside Designated Shellfish Waters Area?

---

---

(xvi) Has the area been classified under Food Safety Legislation? (For Bivalve Molluscs) What is the current classification of the area for the proposed species applied for?

**Yes B**

(xvii) Is the site located in/adjacent to a sensitive area e.g. SPA (Special Protection Area) or SAC (Special Area of Conservation) i.e. a Natura 2000 site? (Refer to Guidance Note 3.3.1- Natura 2000 sites)

**No** \_\_\_\_\_

---

(xviii) Are there known sources of pollution in the vicinity e.g. sewage outfall? Yes / No

If **yes** please give full details.

**No** \_\_\_\_\_

---

(xix) Methods used to harvest the shellfish and details of any subsequent processing of shellfish \_\_\_\_\_

**Harvested by boat into ton bags for local processing**

(xx) Describe any proposed purification facilities to be used:

N/A

(xxi) What are the main predators of the species to be cultivated?

**Starfish** \_\_\_\_\_

(xxii) Describe the method(s) which will be used to control them **Picked by hand or divers** \_\_\_\_\_

**See Part 2.2A for details of documentation to be included with this application type**

## **2.2A DOCUMENTATION REQUIRED FOR MARINE-BASED SHELLFISH AQUACULTURE**

(to be included separately with a Licence Application for a new site or for a renewal or review of an existing Licence)

- 1. An appropriate Ordnance Survey Map (recommendation is a map to the Scale of 1:10,000/1:10,560, i.e. equivalent to a six inch map).** Note: The proposed access route to the site from the public road across tidal foreshore must also be shown on the map.
- 2. Scale drawing of the structures to be used and the layout of the farm.**  
The proposed site drawings must illustrate all site structures above and below the water including mooring blocks. (recommended scales normally 1:100 for structures and 1:200 for layout ) (See Guidance Note 3.3.2)
- 3. The prescribed application fee (See Guidance Note Section 4)**
- 4. If the applicant is a limited Company within the meaning of the Companies Act 1963, as amended, the Certificate of Incorporation and Memorandum and Articles of Association**
- 5. If the applicant is a Co-operative, the Certificate of Incorporation and Rules of the Co-operative Society**
- 6. Environmental Impact Statement (if required) in certain cases- See Guidance Notes Section 3.3.1**
- 7. Alien Species dossier ( where required) – See Guidance Notes Section 3.3.1**

**NOW COMPLETE PARTS 2.6, 3, 4 AND 5 PLEASE**

(xiv) Has the site sufficient space for the site structures including mooring blocks?

\_\_\_\_\_  
Please provide separately detailed drawings of both over and under water structures including moorings.  
(See Guidance Note on Site Structures 3.3.2)

(xv) How will the visual impact issues of the flotation devices for the proposed application be addressed? \_\_\_\_\_

(xvi) Is the site located in a sensitive area e.g. SPA (Special Protection Area) or SAC (Special Area of Conservation) i.e. a Natura 2000 site? (Refer to Guidance Note 3.3.1- Natura 2000 sites)

If Yes give details

\_\_\_\_\_  
\_\_\_\_\_

**See Part 2.3A for details of documentation to be included with this application type**

**2.6 Employment, Qualifications, Experience, etc  
TO BE FILLED IN BY ALL AQUACULTURE APPLICANTS**

(i) Please provide details of experience/qualifications of the applicant and any key personnel which are relevant to the aquaculture now proposed:

**We have been aquaculture farmers since 1982, with extensive experience of all sides of the business**

- (ii) If a new application please provide details of projected employment creation during first four years of the proposed aquaculture project:
- (iii) In the case of a renewal please provide current and future details:

**This is an additional site, when all sites in operation we would employ 6 fulltime staff**

**FULLTIME JOBS**

Year 1:	6	Year 2:	6	Year 3:	6	Year 4:	6
---------	---	---------	---	---------	---	---------	---

**PART TIME JOBS**

Year 1:		Year 2:		Year 3:		Year 4:	
---------	--	---------	--	---------	--	---------	--



**PART 3E DETAILS FOR CONTACT IF DIFFERENT FROM APPLICANT(S)**

**Contact in case of enquiries**

Contact Name	
Organisation Name (if applicable)	
Address	
Telephone No.	
Mobile No.	
E-mail Address	

**PART 3 D. LIMITED COMPANY**

Company Name: **West Cork Seafoods Ltd**

Address: **Drom Leigh South, Bantry, Co. Cork**

Company Registered No. (CRO No.) **601616**

VAT No. **3536448PH**

Phone No. \_\_\_\_\_

Mobile No. **[REDACTED]**

E-mail Address: **[REDACTED]**

Please list below the names and Personal Public Service No's of the Directors of the Company

Name: **[REDACTED]** Personal Public Service No **[REDACTED]**

% Shareholding: **[REDACTED]**

Name: **[REDACTED]** Personal Public Service No **[REDACTED]**

% Shareholding: **[REDACTED]**

Name: \_\_\_\_\_ Personal Public Service No. \_\_\_\_\_

% Shareholding: \_\_\_\_\_

Name: \_\_\_\_\_ Personal Public Service No. \_\_\_\_\_

% Shareholding: \_\_\_\_\_

**CONFIDENTIAL**

**PART 4: FINANCE AND MARKETING**

**PART 4 A. FINANCE**

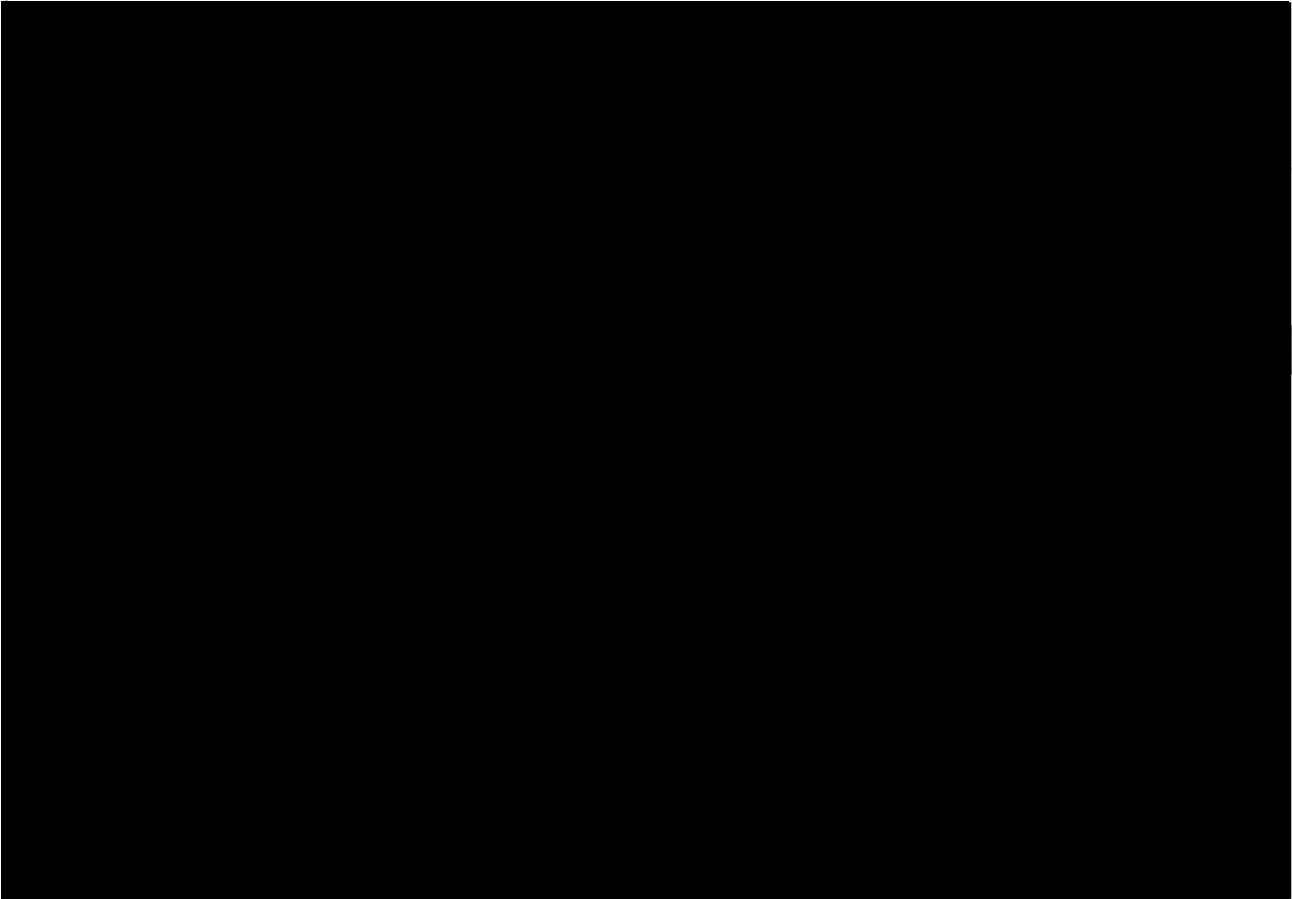

7. Proposed capital costs of project, including navigation marks and lighting.

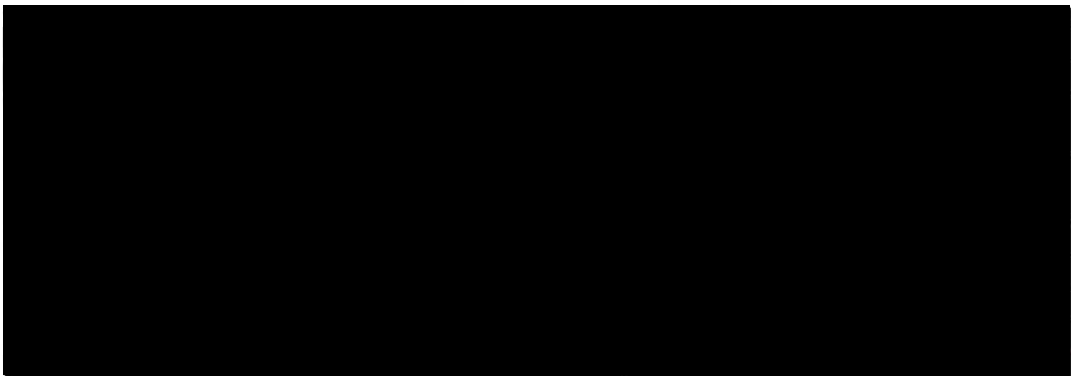
**PART 4 A. FINANCE (continued)**

8. Proposed non-capital costs of project (i.e. seed, feed, labour, etc.):

Item	Cost €
[REDACTED]	[REDACTED]

9. Provide an estimate of the value of production over the first (next if renewal) four years based on projected annual production:

[REDACTED]

10. How many years from the start of the project will it be before you "break even", i.e. your income equals your expenditure?

[REDACTED]

11. Give an estimate of profitability in the longer term, e.g. (5 to 10 years):

[REDACTED]

12. If this application relates to a new site, please set out below the projected production plan to full production by quantities on an annual basis showing stock inputs, growth and harvest production

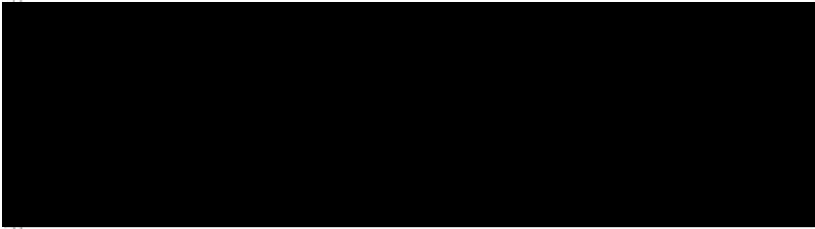

13. If this application relates to an existing site, please set out below the production by quantities on an annual basis for the last 4 years showing stock inputs, growth, survival rates and harvest production

---

---

---

**CONFIDENTIAL**

**PART 4 B. MARKETING**

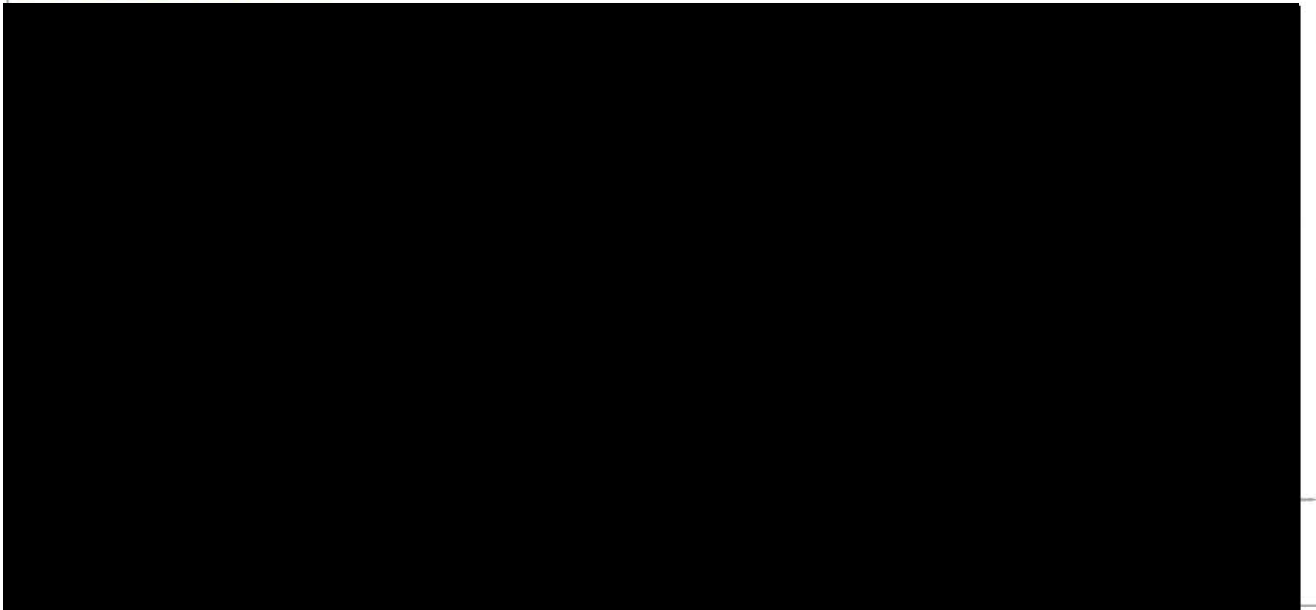

## PART 5: APPLICATION DOCUMENTATION

The following documents are enclosed with this application:

**NB: Refer to Guidance Note Section 3.3 – Guidance on Application Documentation**

No.	DOCUMENTATION	YES	NO	N/A
1	An appropriate Ordnance Survey Map (recommendation is a map to the scale of 1:10,000/10:10,560, i.e., equivalent to a six inch map)	✓		
2	Scale drawing of the structures to be used and the layout of the farm (recommended scales normally 1:100 for structures and 1:200 for layout )	✓		
3	The prescribed application fee			✓
4	Environmental Impact Statement (EIS), if required		✓	
4a	Natura Impact Statement (NIS), if required		✓	
5	Water Quality Analysis Report, if appropriate		✓	
6	Decision of Planning Authority under the Planning Acts, if required		✓	
7	Copy of Licence under Section 4 of the Local Government (Water Pollution) Act, 1977 – Effluent Discharge, if required		✓	
8	If the applicant is a limited Company within the meaning of the Companies Act 1963, as amended, a copy of the Certificate of Incorporation and Memorandum and Articles of Association.	✓		
9	If the applicant is a Co-operative, a copy of the Certificate of Incorporation and Rules of the Co-operative Society		✓	
10	Integrated Pest Management Plan, if required		✓	
11	Alien Species documentation, if required.		✓	

**PART 5: DECLARATION AND SIGNING**

*NB: Refer to Guidance Note Section 3.5 and Section 4 - Guidance on Declaration and Signing and Annual Aquaculture and Foreshore Licence Fees*

If this is a renewal/review have you met all licence conditions of the existing aquaculture licence? If applicable, explain why you have not complied with all conditions:

---

---

---

---

I/We hereby declare the information provided in Parts 1, 2, 3 and 4 above to be true to the best of my/our knowledge. I/We enclose an application fee\* of € N/A with this application.

Signature(s) of Applicant(s):  
(Please state capacity of persons signing on behalf of a Company/Co-op)

Gareth Murphy.  
West Coast Seafoods Ltd

Date: 07/07/2019

**NB All persons named on this licence application must sign and date this application form. Only the existing licence holder(s) can apply for the renewal/review of an Aquaculture Licence.**

\*Preferred method of payment is by cheque or bank draft. The fee should be made payable to the Department of Agriculture, Food and the Marine.

*Refer to Guidance Note Section 4 - Guidance on Aquaculture and Foreshore Licence Fees*

The application form should be forwarded, with the required documents and application fee, to:

**Aquaculture Licensing  
Aquaculture & Foreshore Management Division  
Department of Agriculture, Food and the Marine  
National Seafood Centre  
Clonakilty  
Co. Cork**

**1 NO. SITE AT BANTRY BAY CO.CORK**

**Co-ordinates & Area**

**Site T05/430A (24.2029 Ha)**

The area seaward of the high water mark and enclosed by a line drawn from Irish National Grid Reference point

087601, 043679 to Irish National Grid Reference point  
087464, 044065 to Irish National Grid Reference point  
088040, 044266 to Irish National Grid Reference point  
088168, 043903 to the first mentioned point.

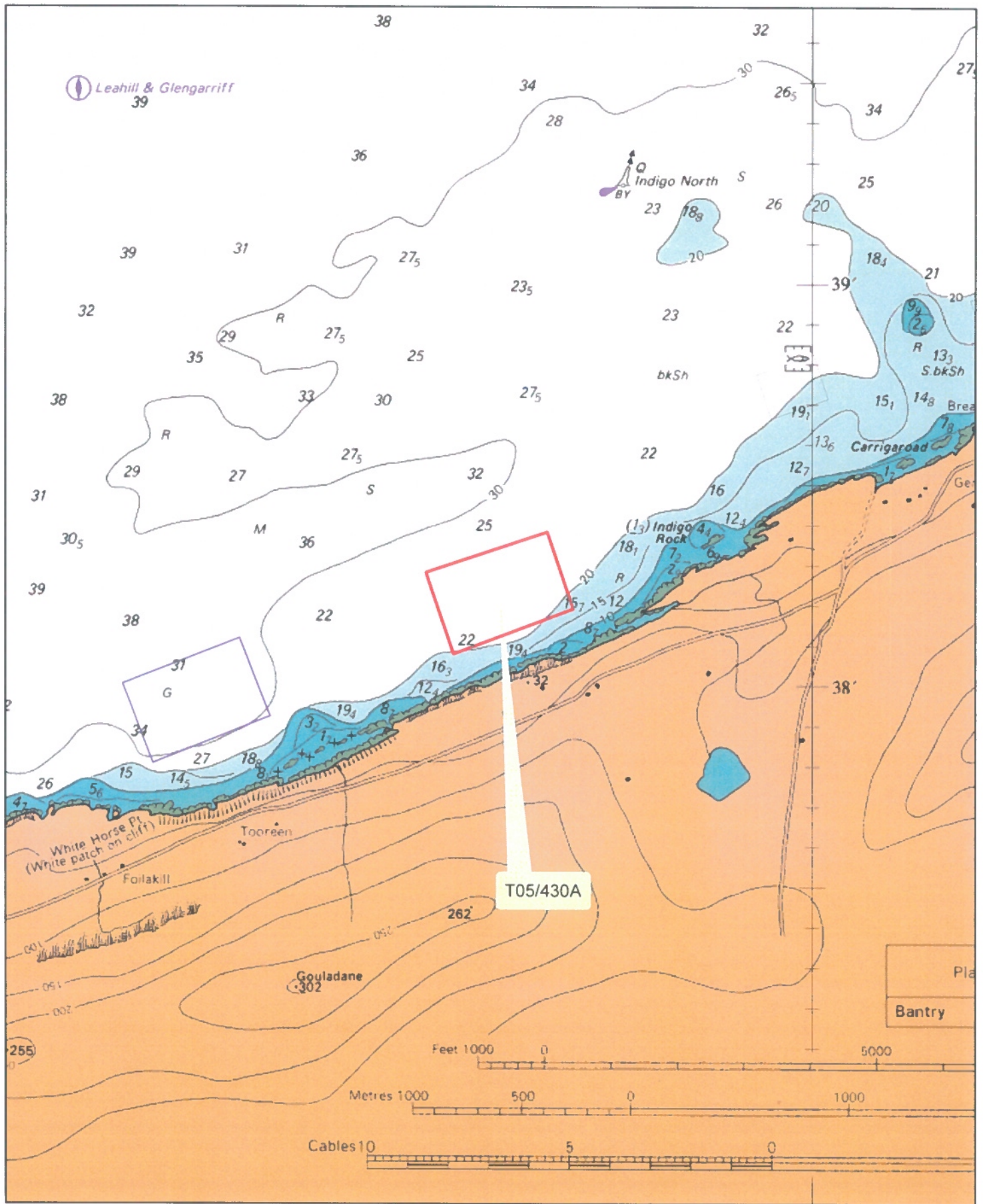

- Aqua Culture Sites**  
 <all other values>
- Site\_Status**
- Under Appeal
  - Application
  - Lapsed
  - Licensed
  - Refused
  - Revoked
  - Surrendered
  - Withdrawn

**1:24,000**

Sites highlighted in red denotes Application

Part of Admiralty Chart No =1838-0  
 Not to be used for Navigation



**An Roinn Talmhaíochta,  
 Bia agus Mara**  
 Department of Agriculture,  
 Food and the Marine



88000

89000

44000

44000

43000

43000

88000

89000



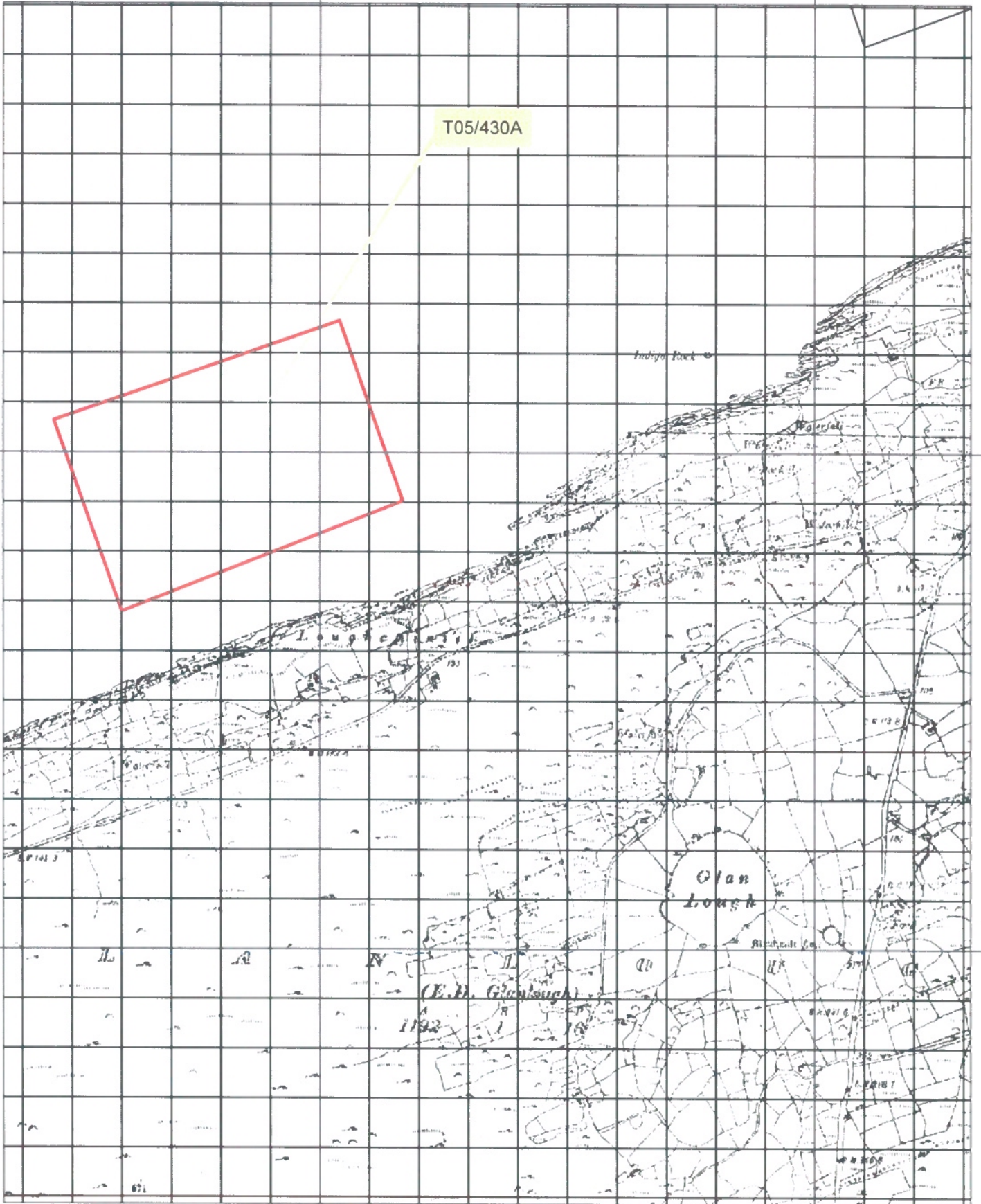





T05/430A



**Aqua Culture Sites**

<all other values>

**Site\_Status**

-  Under Appeal
-  Application
-  Lapsed
-  Licensed
-  Refused
-  Revoked
-  Sumendered
-  Withdrawn
-  100 Meter Reference Grid

1:10,560

Sites highlighted in red denotes Application

Ordnance Survey Ireland Licence No. EN 0076418  
© Ordnance Survey Ireland/Government of Ireland



**An Roinn Talmhaíochta,  
Bia agus Mara**  
Department of Agriculture,  
Food and the Marine

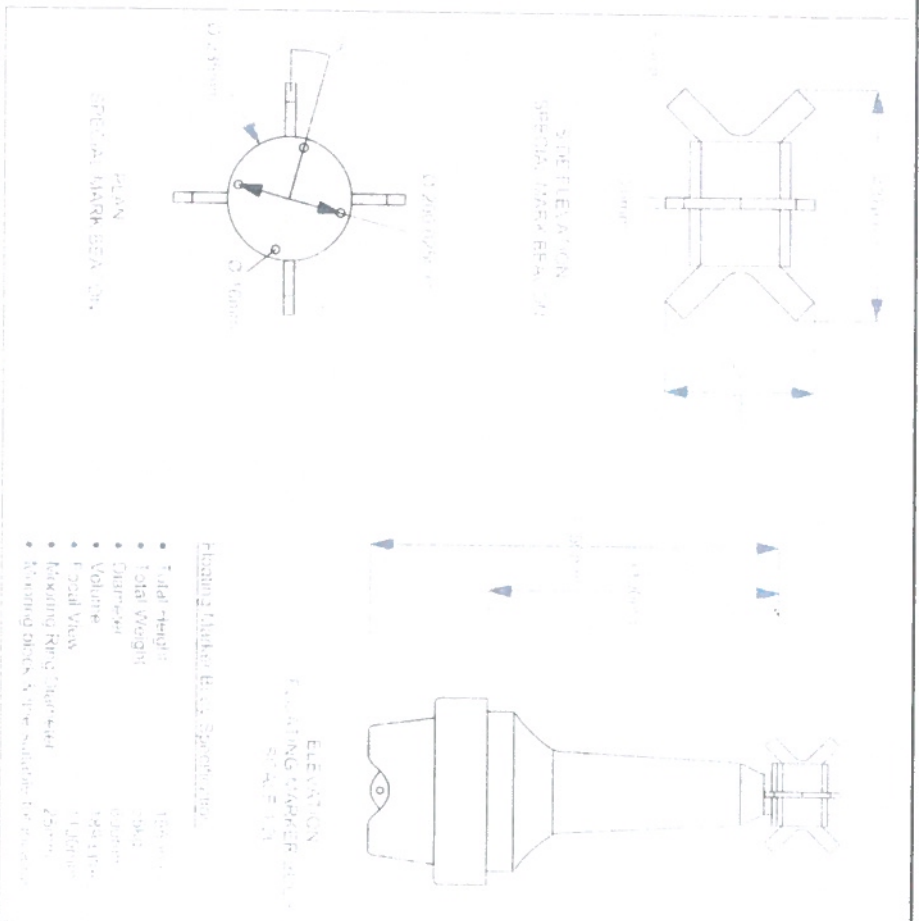

# Floating Marker Buoy Detail 1:10 & 1:20



# Orientation Layout 1:15,000

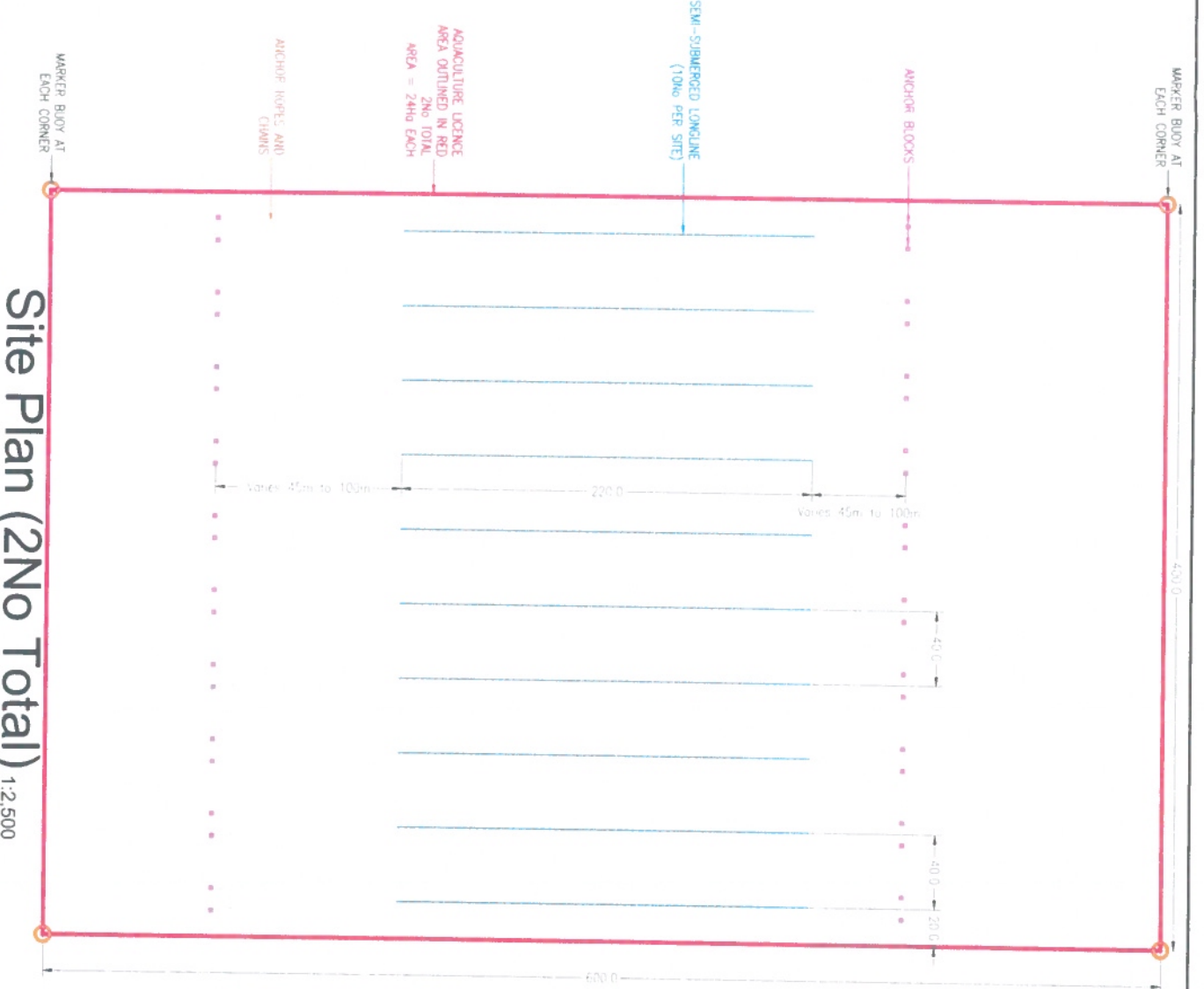

Client: WEST CORK SEAFOODS LTD  
 Project: AQUACULTURE LICENCE APPLICATION, FOLIAKILLY/GLANLOUGH, BANTRY BAY, CO. CORK  
 Drawing Status: ISSUE FOR AQUACULTURE LICENCE  
 Drawing Title: SEM-SUBMERGED SINGLE HEADROPE LINE DETAILS  
 Scale: A3 - AS SHOWN  
 Date: 05/5 OK

Client: Gerard Harrington Arch Tech 85c  
 Prepared by: John J. O'Sullivan, BE C.Eng. MIEI  
 Date: 31/01/2019  
 Drawing No: L00051902-00

GLENN DESIGN PARTNERSHIP T/A  
**JOHN J. O'SULLIVAN & ASSOCIATES**  
 Planning & Architectural Consultants - Consulting Engineers & Surveyors  
 Lincduh, Rossmoen East, GLENGARRIFF, Co. Cork, P75 YX92 Ireland  
 Tel: 027 63126 - Fax: 027 63557 - Office email: info@jjs.ie - Website: www.jjs.ie

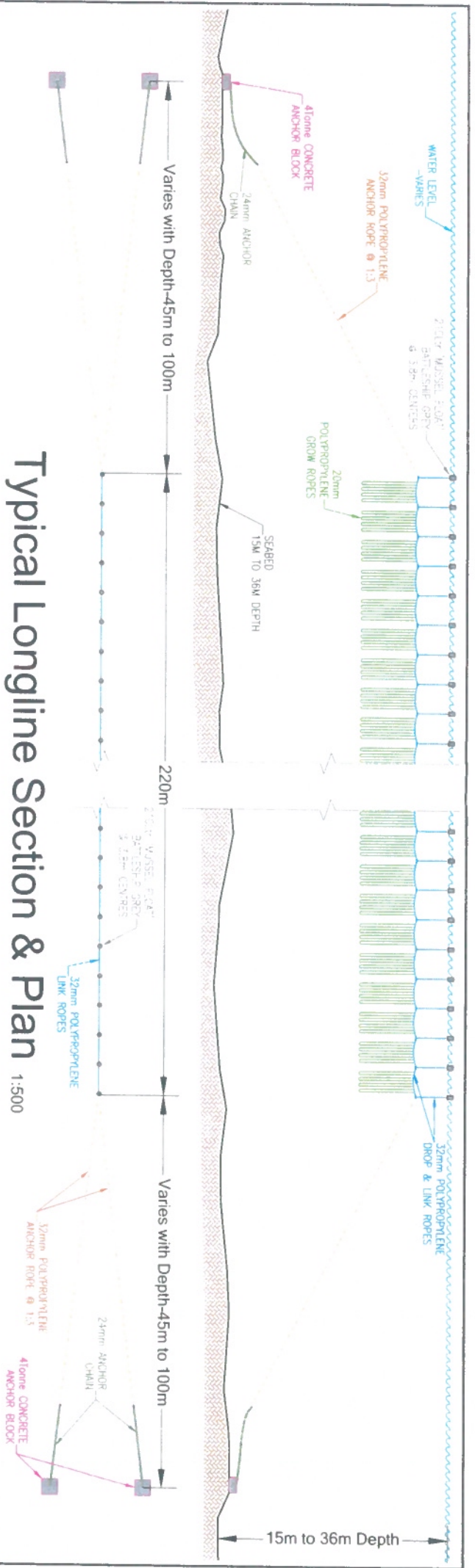

Typical Longline Section & Plan 1:500

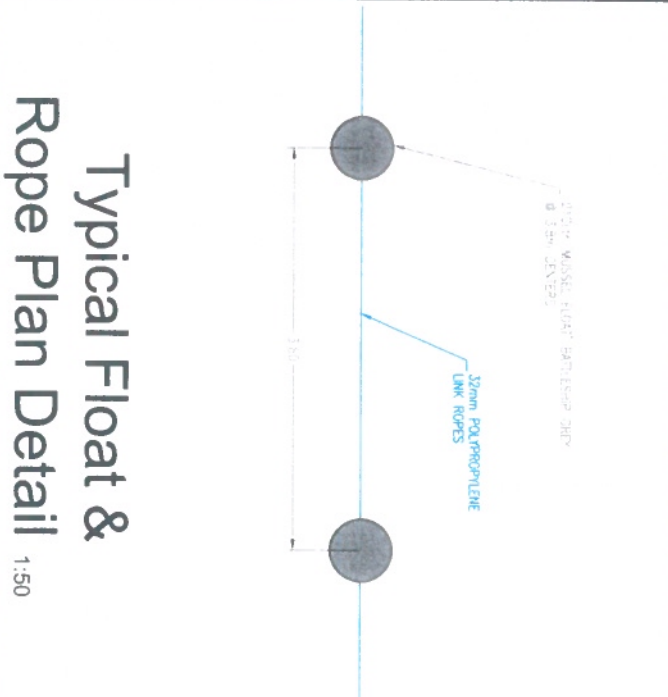

Typical Float & Rope Section Detail 1:100

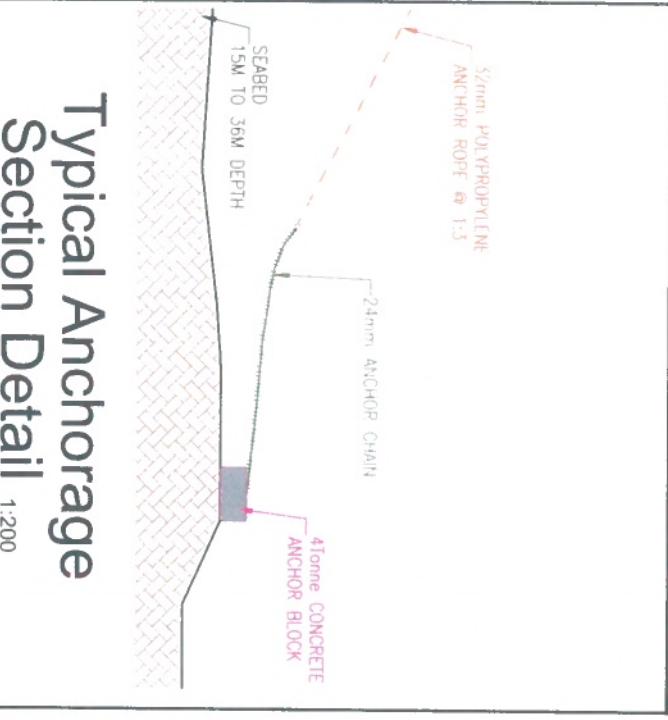
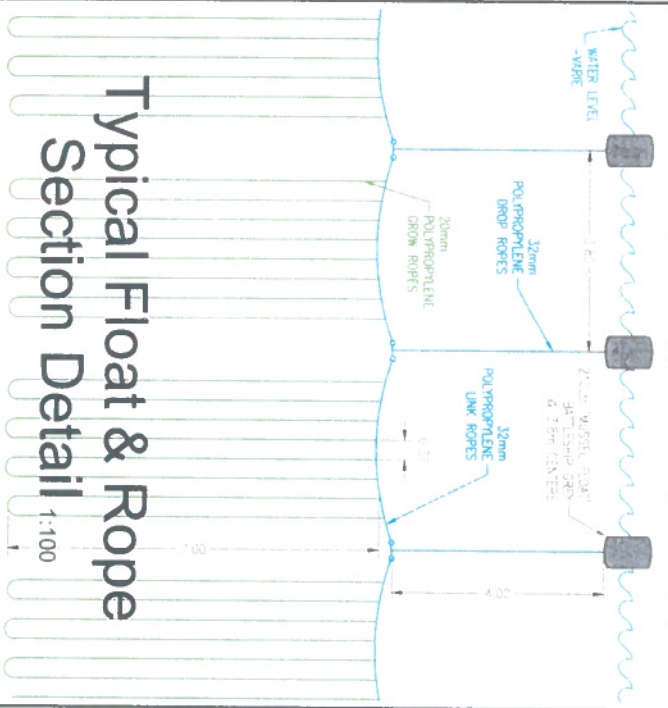

Typical Anchorage Section Detail 1:200

Client: WEST CORK SEAFOODS LTD  
 Project: AQUACULTURE LICENCE APPLICATION  
 FOILAKILLY/GLANLOUGH, BANTRY BAY, CO. CORK

Drawing Title: ISSUE FOR AQUACULTURE LICENCE  
 Scale: A3 - AS SHOWN  
 Date: 31/01/2019

Drawn By: Gerard Harrington Arch Tech BSc  
 Checked By: John J. O'Sullivan, BE CEng MIEI

JOHN J. O'SULLIVAN & ASSOCIATES  
 Planning & Architectural Consultants - Consulting Engineers & Surveyors  
 'Lindhu', Reenmoan East, GLENGARRIFF, Co. Cork, P75 YX92 Ireland  
 Tel: 027 63126 - Fax: 027 63957 - Office email: info@jjs.ie - Website: www.jjs.ie

Drawn To: L00051902-00



**Marine Engineering Division**  
**Report on Aquaculture Licence Application**

**Application Reference No:** T05/430

**Report Prepared by:** Raphael Crowley

**Date:** 22 February 2019

**Applicant:** West Cork Seafoods Ltd.

**Location:** Glanlough, Bantry Bay, Co. Cork

**Applicant Type:** Aquaculture/Foreshore Licence

**Site**

A	B	Total
24.20	24.20	48.40

**Site Area (Ha)**

**Species:** Blue Mussel (*mytilus edulis*)

**Cultivation Method:** Single submerged longline

**Intertidal/Non-Intertidal:** Non-Intertidal

**Source of Seed / Spat:** Naturally occurring

**Annual Production Estimates:** Mussels - 280 Tonnes (140 Tonnes per site)

**Shellfish Waters Designation:** Yes  No   
Reference: Map 44: Bantry Bay South

**Environmental Designation:** Yes  No   
Reference:

**Development Plans:** Yes  No   
Reference: Cork County Development Plan 2014, Section 6.11

**Pre-Consultation Meeting:** Yes  No   
Date: Various

## Drawing Validation Sheet

**OSI Maps** Yes  No

Comment:

**BA Chart** Yes  No

Comment:

**Farm Layout Drawing** Yes  No

Directional Arrow	Yes	<input checked="" type="checkbox"/>	No	<input type="checkbox"/>
Scale	Yes	<input checked="" type="checkbox"/>	No	<input type="checkbox"/>
Title Block	Yes	<input checked="" type="checkbox"/>	No	<input type="checkbox"/>
Date	Yes	<input checked="" type="checkbox"/>	No	<input type="checkbox"/>

Comment: Drawings provided are suitable.

**Drawings of structures** Yes  No

Comment: Drawings provided are suitable.

**Details of Proposed Navigation Marking** Yes  No

Comment: Drawings provided are suitable.

**Site Access Indicated** Yes  No

Comment: Access from Gerahies Pier.

**Site Co-Ordinates Indicated** Yes  No

Comment: Co-ordinates provided.

**Site Overlap** Yes  No

Comment:

**Oyster Fishery Order Overlap** Yes  No

Comment:

**The application is submitted with each of the requirements listed and is therefore deemed to be a valid application.**

**AFMD should be aware that insufficient details have been submitted as per above.**

## **Site Suitability Assessment**

### **Background**

An application for two sites T05/430 A&B at this location was originally submitted in 1998 and was assessed in 2000 by Marine Engineering Division (MED). The MED recommendation in 2000 was that the application be refused on visual impact grounds. Following an indication that one of the sites would use “smart farm” technology, a further visual impact assessment was undertaken in 2003 and the MED recommendation was that the application be refused.

The applicant subsequently met with Aquaculture and Foreshore Management Division (AFMD) and indicated that he wished to proceed with the application using longlines only and have the original application determined. The applicant pointed out a number of inaccuracies in the MED reports. Revised individual applications for the two sites, with detailed documents, were submitted in 2019. MED has now reviewed the contents of the original application and MED reports and the new application documentation and submits the following as the current position regarding these applications.

### **Site Location**

The sites are located at a relatively exposed location at Glanlough along the south shore of Bantry Bay. The proposed sites are adjacent to the roadway from Bantry via Gerahies to Kilcrohane. There are mussel longline sites to the west and east of the proposed application sites, as well as a number of salmon farm sites to the east, which indicates that the hydrodynamic regime at this location is suitable for this type of aquaculture.

### **Site Management**

These applications are for mussels grown on 220 metre single head-rope longlines. The applicant operates a number of other sites in Bantry Bay. The sites are currently not in use.

### **Proposed Site Layout and Structures**

These applications are for mussels grown on 220 metre single head-rope longlines. Details of the farm layouts and structures have been submitted and are suitable. The flotation barrels should be battleship grey in colour. The farm layouts and type of structures proposed are in accordance with the best practices outlined in the Guidelines for Landscape and Visual Impact Assessment of Marine Aquaculture, 2001.

### **Land Based Facilities / Site Access**

The sites will be accessed from Gerahies Pier, and access has been indicated in the site location drawings.

### **Navigation**

If licenced, these sites will require navigation marking and the MSO should be consulted regarding providing a safe system of navigation for all marine users. Details of proposed navigational markings has been provided.

### **Visual Impact**

Details of farm layouts and details of the type of structures have been submitted for assessment, and are in accordance with the best practices outlined in the Guidelines for Landscape and Visual Impact Assessment of Marine Aquaculture, 2001.

The contents of the 2003 MED visual impact assessment have been reviewed in light of the issues raised by the applicant. It is accepted that the proposed sites are not readily visible

from Location 3 as indicated in the 2003 MED report; the reference to the 280 hectares in inner Bantry Bay is not relevant to this application; and there are no lay-bys or designated viewing points at this location.

The terrestrial area adjacent to these applications is designated as high value scenic landscape. The local county road adjacent to these applications is designated as a scenic route (S110) in the Cork County Development Plan 2014 and is part of the Wild Atlantic Way. The views from the road are of Bantry Bay and the mountains of the Beara Peninsula to the north. The Sheep's Head Way, a marked walking route passes along the mountain to the south of the public road. The views from the Sheep's Head Way are of Dunmanus Bay and Mizen peninsula to the south; Sheeps Head to the east and west; and Bantry Bay and the mountains of the Beara Peninsula to the north. The area is lightly populated and there is a farm guesthouse to the south of Site T05/430A.

There are licenced aquaculture sites for mussel longlines along the coastline to the west and east of these applications; and licenced salmon farm sites to the east at Gerahies. These existing aquaculture sites are as visible from the road and walkway as the sites of these applications; and are of a similar nature and scale to the proposed sites. Any viewers in the vicinity of these applications will have passed these existing sites and will be aware of aquaculture in this area.

Travelling in a westerly direction along the roadway, Site T05/430A is not visible due to vegetation and topography, while T05/430B becomes visible as the road rises and the viewer approaches the site. Travelling in an easterly direction and as the road descends, Site T05/430B is visible briefly and T05/430A becomes visible in the distance along a section of approximately 500 metres of roadway. The existing aquaculture sites at Gerahies are visible to the east also.

Given that aquaculture already exists along this coastline; the proposed sites are small in the context of the overall available scenic views from both the public road and the walkway; the farm layouts and type of structures adhere to the best practices outlined in the Guidelines for Landscape and Visual Impact Assessment of Marine Aquaculture, 2001; the area is lightly populated; and this road is not heavily trafficked and does not have designated laybys or public viewing areas at this location, I believe that the visual impact is moderate and the applications should not be refused on visual impact grounds.

### **Impact / Cumulative Impact**

There are no other aquaculture applications at this location that would result in a cumulative impact. The existing aquaculture has become embedded in the landscape and these applications are small in scale and do not significantly increase the licenced aquaculture area in the context of the bay. There is fishing and marine leisure in the area.

**MED has no objection to the licencing of these sites.**



21<sup>st</sup> March 2019

Tina Foley  
Sea Fisheries Protection Authority  
National Seafood Centre  
Park Road  
Clogheen  
Clonakilty  
Co. Cork

**Ref: T05/430A & T05/430B – West Cork Seafoods Ltd**

The sites applied for in the above application would appear to be located directly over potting and scallop dredging ground as per consultation with local fishermen and as such have the potential to impact on existing fishing activity.

These site are located within the Bantry Outer classified area which is currently not classified for the production of Mussels. A sampling regime as required under the SFPA Code of Practice for the Microbiological Monitoring of Bivalve Mollusc Production Areas, would have to be undertaken prior to the harvesting of Mussels within the Bantry Outer area. The granting of the license applications T05 430 A & B, would necessitate the cooperation of the producer in facilitating access to the site in order to obtain samples for the Classification, Shellsan and Biotoxin monitoring programs.

Yours sincerely

Sean Murran  
Sea-fisheries Protection Officer  
Sea-Fisheries Protection Authority  
Castletownbere  
Co. Cork

Phone: 027-70439



Date: 13 March 2019

Thérèse O’Keeffe  
Aquaculture and Foreshore Management Division  
Department of Agriculture, Food and the Marine  
Clogheen,  
Clonakilty  
Co. Cork.

**Advice on Aquaculture Licence Application**

<b>Applicant</b>	<b>West Cork Seafoods Ltd</b>
<b>Application type</b>	<b>New</b>
<b>Site Reference No</b>	<b>T05/430 A and B</b>
<b>Species</b>	<b>Mussels (<i>Mytilus edulis</i>) – longlines</b>
<b>Site Status</b>	<b>Not located within a Natura 2000 Site Located within the Bantry Bay South designated Shellfish Growing Waters Area.</b>

Dear Thérèse

This is an application for an aquaculture licence to cultivate mussels (*Mytilus edulis*), using longlines, at Sites T05/430A and T05/430B in Bantry Bay, Co. Cork. The area of foreshore at Site T05/430A is 24.2029Ha while the area of foreshore at Site T05/430B is 24.0863Ha.

No chemicals or hazardous substances will be used during the production process.

The cultivation of shellfish at this site will produce faeces and pseudofaeces. Any impact will be limited to the area of the site. The build-up of excess organic matter beyond the footprint of the sites is not considered likely.

Considering the location, nature and scale of the proposed aquaculture activity, and in deference to our remit under the Marine Institute Act, and the considerations implicit to Sections 61(e and f) of the Fisheries (Amendment) Act, 1997 the Marine Institute is of the view that there will be no significant impacts on the marine environment and that the quality status of the area will not be adversely impacted

Sites T05/430A and T05/430B are located within the Bantry Bay South designated Shellfish Growing Water Area.

Mussels do not appear to be currently classified under Annex II of EU Regulation 854/2004 in this part of Bantry Bay. It is recommended that the views of the SFPA should be sought in this regard.

Sites T05/430A and T05/430B are not located within a designated Natura 2000 site and, as set out in the AA Screening Report for outer Bantry Bay<sup>1</sup>, the Marine Institute is of the view that significant impacts on any adjacent Natura 2000 are not likely.

In order to be able to assess and manage the potential risk of the introduction of invasive non-native species the MI recommends that the initial source of seed and other sources which may be used at any point in the future should be approved by the Minister. This approval should be a specific condition of any licence that may issue. It should be noted that the control of alien species is a separate issue to the control of diseases in the context of the current Fish Health legislation.

<sup>1</sup>

<https://www.agriculture.gov.ie/media/migration/seafood/aquacultureforeshoremanagement/aquaculturelicensing/aquacultureforeshorelicenceapplications/cork/2019/ScreeningMatrixforAquacultureActivitiesinOuterBantryBay060319.pdf>

Notwithstanding the recommendation outlined above, and in the event that an Aquaculture Licence is granted, the movement of stock in and out of the site should follow best practice guidelines as they relate to the risk of introduction of invasive non-native species (e.g. [Invasive Species Ireland](#)). In this regard it is recommended that, prior to the commencement of operations at the site, the applicant be required to draw up a contingency plan, for the approval of DAFM, which shall identify, *inter alia*, methods for the removal from the environment of any invasive non-native species introduced as a result of operations at this site. If such an event occurs, the contingency plan shall be implemented immediately.

In the event that invasive non-native species are introduced into a site as a result of aquaculture activity the impacts may be bay-wide and thus affect other aquaculture operators in the bay. In this regard, therefore, the Marine Institute considers that the CLAMS process may be a useful and appropriate vehicle for the development and implementation of alien species management and control plans.

It is statutory requirement that a Fish Health Authorisation as required under Council Directive 2006/88/EC be in place prior to the commencement of the aquaculture activities proposed.

Kind regards,

A handwritten signature in black ink, appearing to read 'Terry McMahon', written over a horizontal line.

---

Dr. Terry McMahon  
Section Manager, Marine Environment and Food Safety Services,  
The Marine Institute.

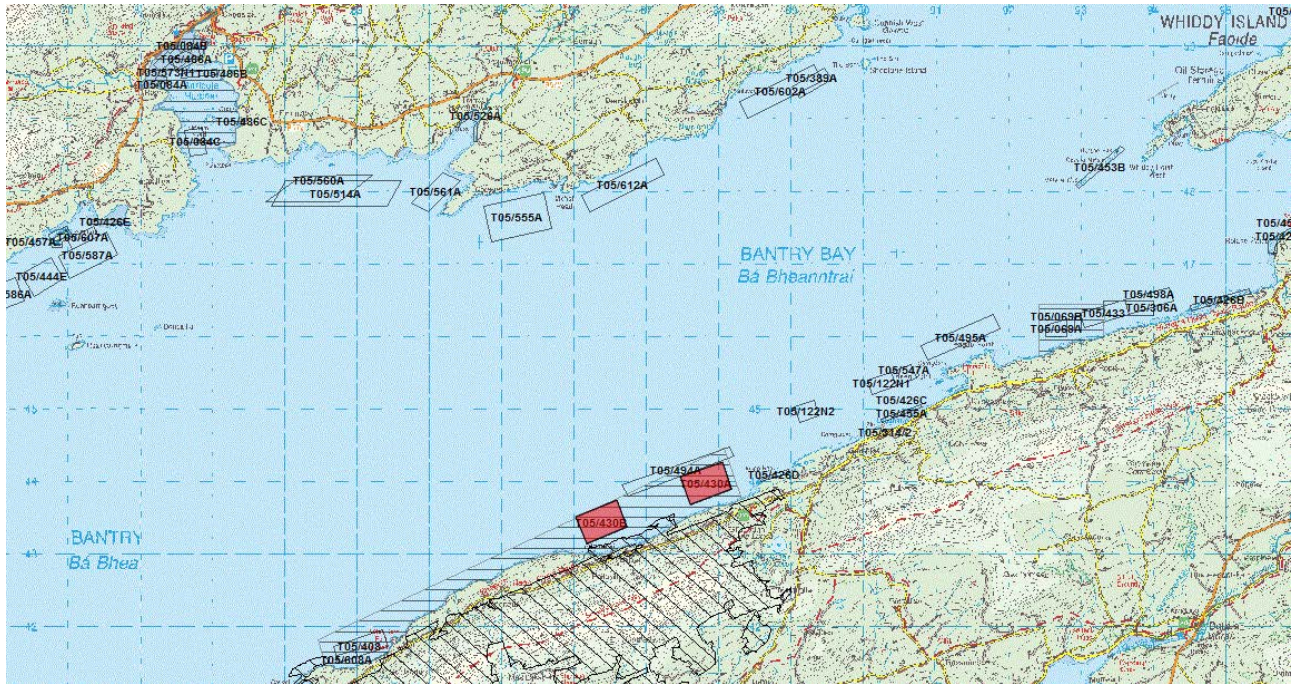

Shellfish Waters Directive Area



Aquaculture Site



Special Area of Conservation



Special Protection Areas



## Fishing in Bantry Bay and licencing of applications T05430A and T05430B

*Oliver Tully, Marine Institute, Sept 24<sup>th</sup> 2019*

Aquaculture licence applications T05430A and T05430B are for long line cultivation of mussel on the south shore of Bantry Bay. The following fisheries occur in the Bay

1. Shrimp
  - a. August to March
  - b. Pots
  - c. Shallow mixed sediments and edge of reef
2. Lobster and crab
  - a. All year
  - b. Pots
  - c. Reef
3. Prawns and demersal fish
  - a. All year
  - b. Trawls and pots
  - c. Outer and middle on mud sediments
4. Scallops
  - a. All year potentially
  - b. Dredges
  - c. Gravel and coarse sediments
5. Pelagic trawling
  - a. Winter
  - b. Pelagic pair trawl
  - c. Midwater

Existing information on fishing activities is based on VMS data for vessels over 12m in length. The majority of activity in the Bay, especially in shallow waters along the shoreline, is by vessels under 12m in length. Information on activity of such vessels was compiled by the Marine Institute in 2013/2014 using expert judgement and consultation with SFPA, BIM and industry. The known fishing activity in the region, derived from these sources, is shown in the maps below. The resolution of the data for vessels under 12m is low and it is not possible to quantify overlaps and the extent to which fishing ground would be lost due to licencing of applications T05430A and T05430B. High frequency VMS data would be needed to resolve activity to the scale relevant to the aquaculture applications.

Furthermore, it is not possible to comment on the degree to which licencing of the applications would have a negative impact on fishermen's livelihoods. This would only be possible if the area of ground lost could be estimated and the earnings per area of ground could be estimated from fish landings and value data referenced to the area. This could be compared to the earnings that would be provided through licencing of the aquaculture applications and a relative cost benefit analysis undertaken.

In summary there is likely to be some overlap between the licence applications and shrimp, lobster, crab and perhaps scallop fisheries and therefore some loss of fishing ground. This loss is small

relative to the total area of fishing ground available but there is also incremental and cumulative loss in fishing ground as each individual aquaculture licence application is granted.

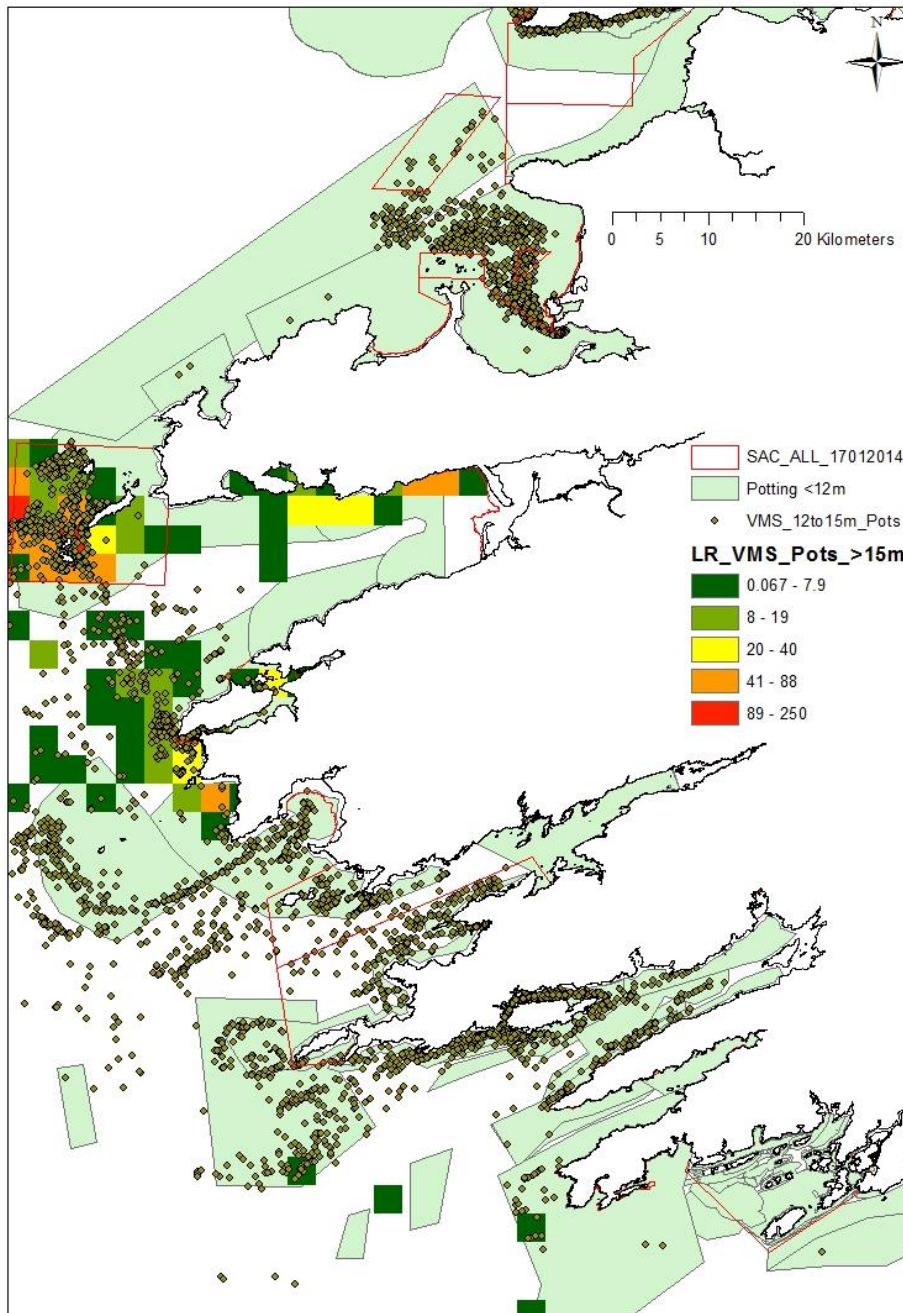

Figure 1. Potting activity in the south west including Bantry Bay. Potting by vessels 12-15m on the south shore of Bantry Bay is evident from VMS. Potting for shrimp, lobster and crab occurs in the inner Bay especially towards the edges on coarse sediments and reef.

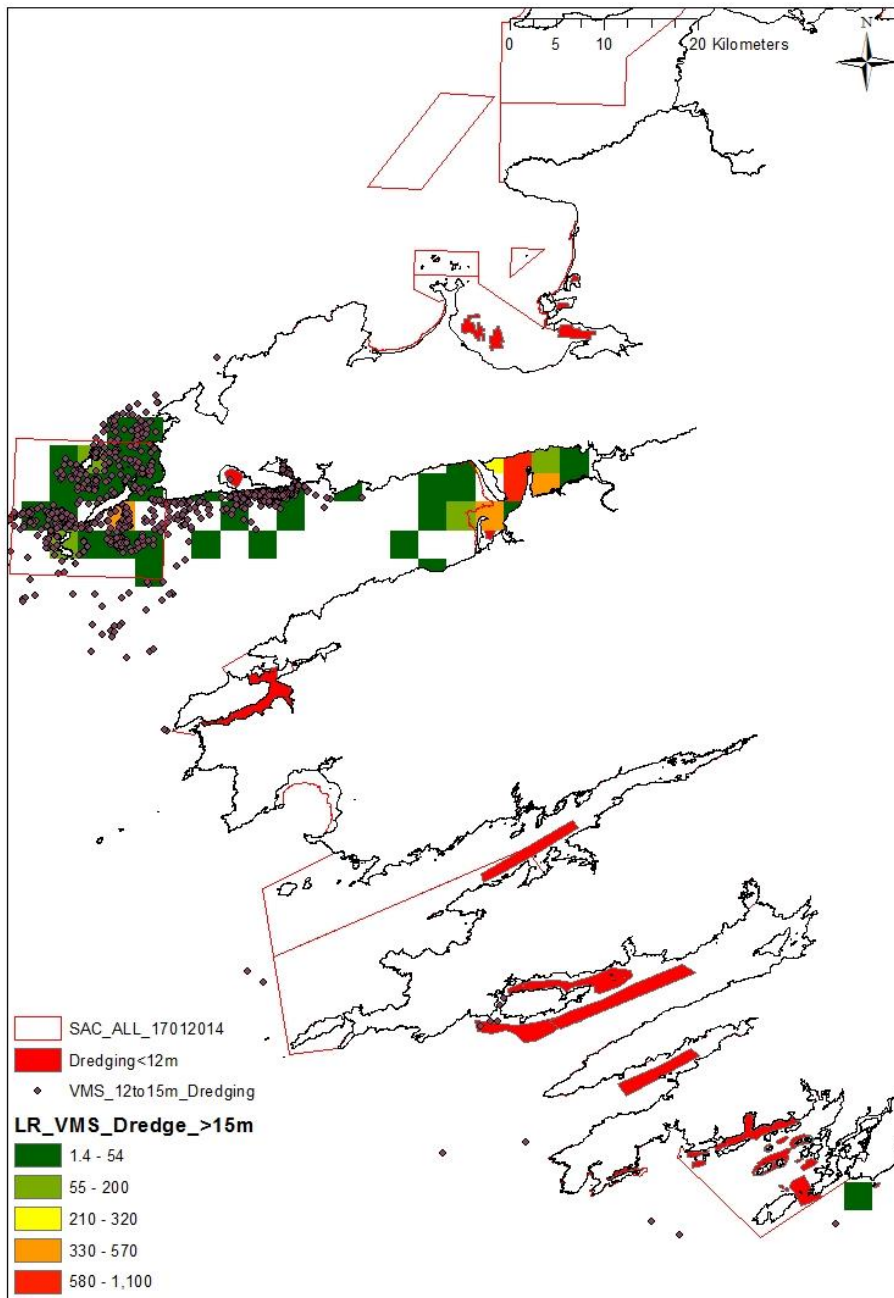

Figure 2. Dredging activity in the south west including Bantry Bay. Dredging is mainly for scallops. The grounds in Bantry Bay may extend also along the south shore

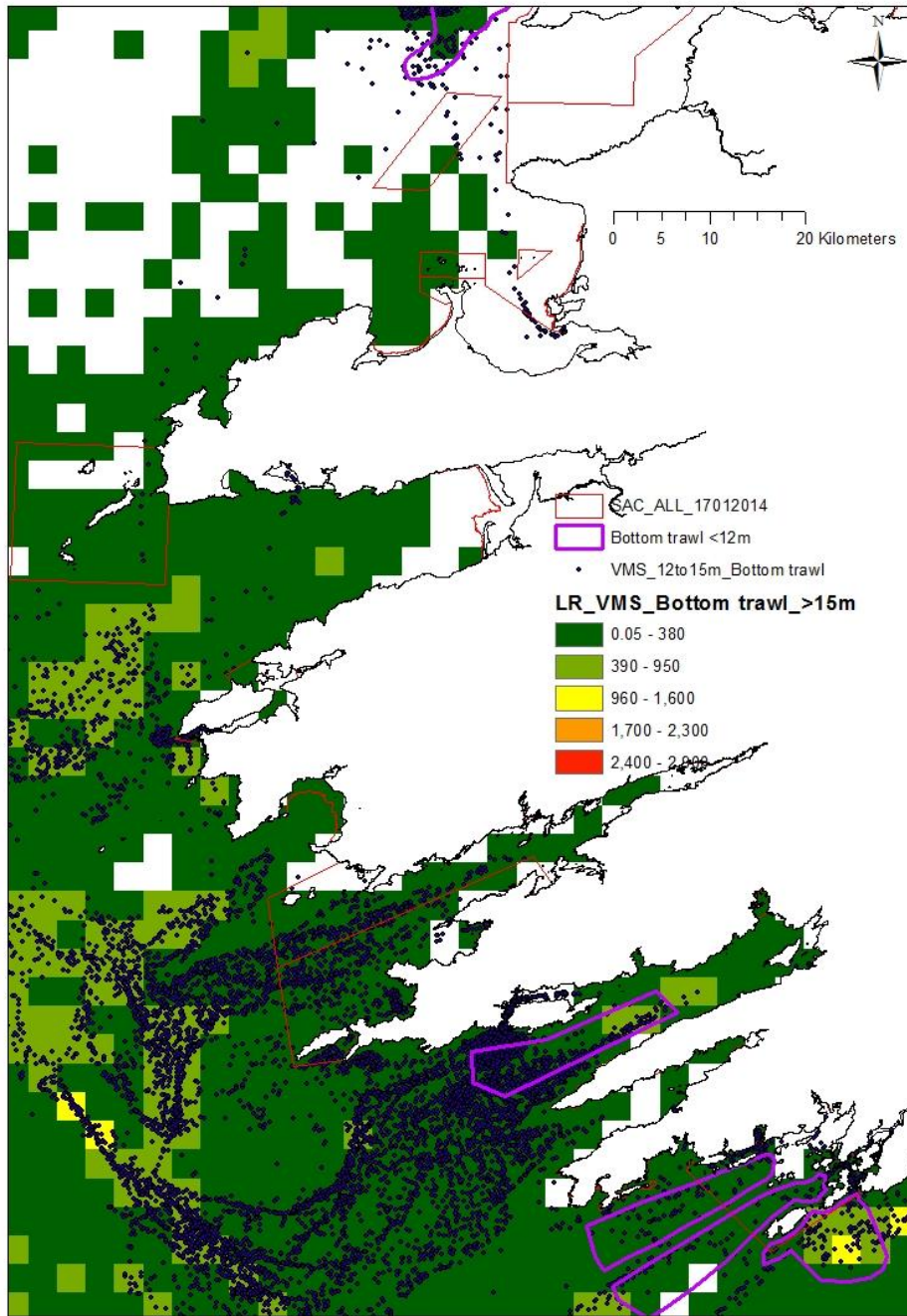

Figure 3. Trawling activity in the south west including Bantry Bay. There is limited or no trawling on the south shore. Trawling is concentrated in the middle and outer Bay on mud sediments targeting prawns.

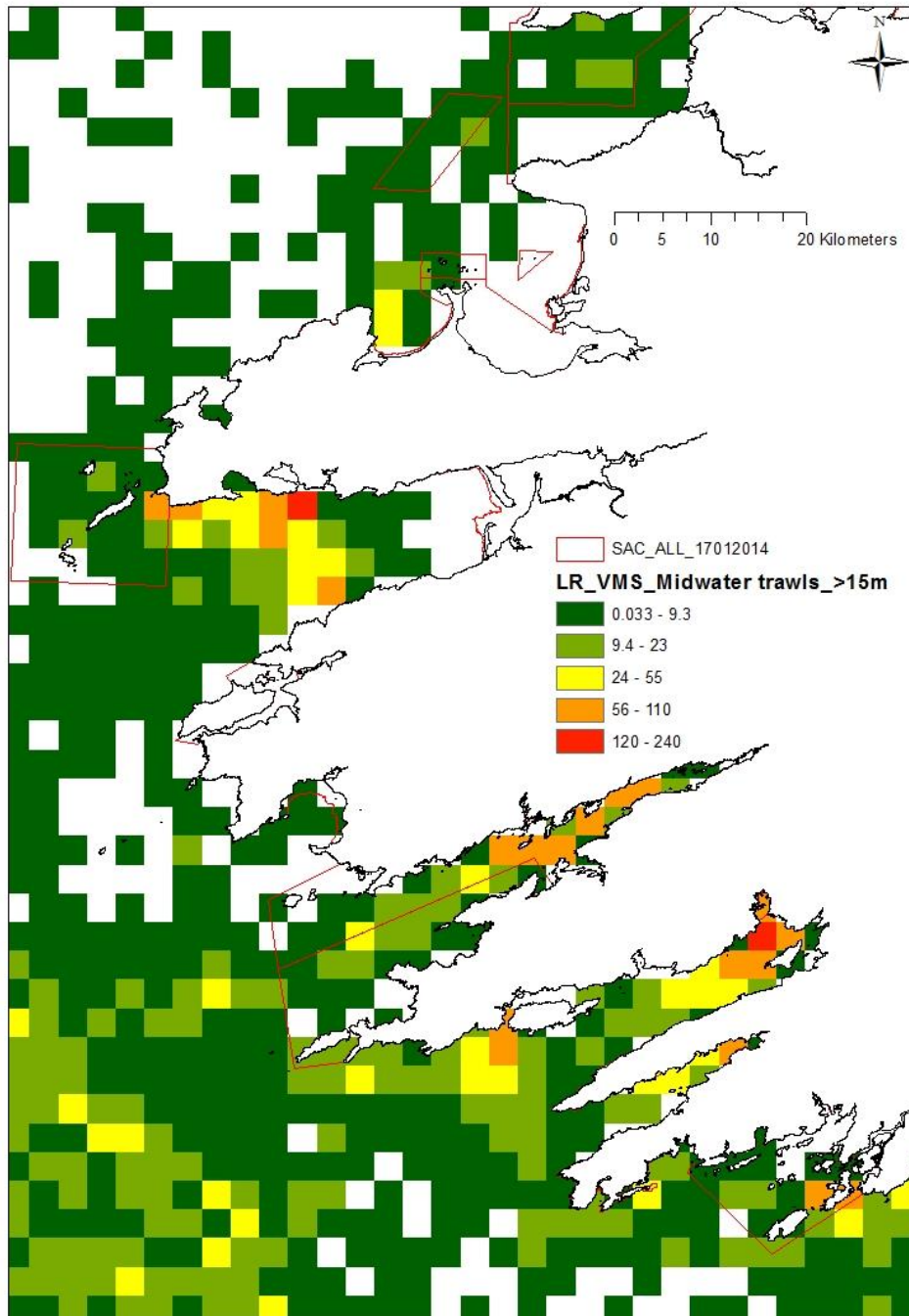

Figure 3. Midwater trawling activity in the south west including Bantry Bay. Higher levels of activity is associated with winter fishing for sprat in inner Bantry and Kenmare Bays.





Ms. Therese O'Keeffe  
Aquaculture and Foreshore Management Division  
Dept. of Agriculture Food & the Marine  
National Seafood Centre  
Clonakilty  
Co. Cork

*Your Reference:* T05/430A

*Our Reference:* LA:0566.3860

*Date:* 04/04/2019

**LL: LA 0566.3860**

**Applicant:** West Cork Seafoods Ltd

**Site:** Bantry Bay, Co. Cork

Dear Ms. O'Keeffe,

Thank you for your letter advising us of this application.

Based on the information supplied, there appears to be no objection to the development. It is important to ensure that no navigable inter-tidal channels are impeded by the site.

If a licence is granted, all structures must be clearly marked as required by Regulations and Licensing Permit conditions and to the approval of the Nautical Surveyor with the Marine Survey Office.

We would request that you include the following terms in the licence—

- That the applicant secures Statutory Sanction from the Commissioners of Irish Lights for the aids to navigation that may be required by the Marine Survey Office. These aids should be in place before development on the site commences. Statutory sanction forms are available at <http://www.irishlights.ie/safety-navigation/statutory-sanction.aspx>
- The size and specification of aids to navigation should be of the design and specification approved by the Marine Survey Office and must be agreed in advance with the Commissioners of Irish Lights.

It is recommended that local fishing and leisure interests be consulted prior to a decision being made.

Furthermore, if a licence is granted, the UK Hydrographic Office at Taunton: [sdr@ukho.gov.uk](mailto:sdr@ukho.gov.uk) must be informed of the development's geographical position in order to update nautical charts and other nautical publications.

Yours sincerely,

**Neil Askew**  
**for Director of Operations and Navigation**

cc Capt. T. O'Callaghan, Dept. of Transport Tourism & Sport, Marine Survey Office

## Bantry Bay Screening

Screening Matrix for Aquaculture activities in outer Bantry Bay, Co. Cork	
Brief description of the project or plan	<p>The following species are cultured in outer Bantry Bay (number of licences in parenthesis) - oysters (10) clams (1) abalone (1), sea urchins (1), mussels (8), and finfish (4). Additionally, applications have been received for the following species - oysters (12), scallops (5), clams (1), sea urchins (2), mussels (13), kelp/seaweed (1) and finfish (1). The locations of the sites are shown in Figure 1.</p>
Brief description of the Natura 2000 sites	<p>Bantry Bay is approximately 39km long and ranges in width from 3km at the eastern end to 22km at the mouth. The area of outer Bantry Bay in question is not located within any Natura 2000 sites. However, - it is bordered by two SACs, the Sheeps Head cSAC and the Glengarriff Harbour and Woodland SAC and two SPAs, Beara Peninsula SPA and Sheeps Head to Toe Head SPA. (see Figure 1).</p> <p><b>Adjacent Sites:</b></p> <p><b>Sheep's Head SAC (Site code: 000102)</b> is located on the southern approaches to Bantry Bay, extends to Three Castle Head and Mizen Head to the south. It is a narrow ridge of sandstone which encloses a number of rectangular basins filled either by peat bogs or lakes. The main value of the area is the presence of the terrestrial features, dry heath and wet heath, habitats listed on Annex II of the EU Habitats Directive. In addition, Annex I Birds Directive species, the Chough, and an Annex II species under the Habitats Directive, the Kerry Slug, are found in the area.</p> <p><b>The Glengarriff Harbour and Woodland SAC (Site Code 00090)</b> consists of a glacial valley opening out into a sheltered bay with rocky islets. The site supports populations of the Kerry Slug (<i>Geomalacus maculosus</i>), the freshwater Pearl Mussel (<i>Margaritifera margaritifera</i>) as well as the largest colony of Common Seals (<i>Phoca vitulina</i>) in the south-west of Ireland, all of which are listed on Annex II of the Habitats Directive.</p> <p><b>Beara Peninsula SPA (Site Code: 004155)</b> is a coastal site parts of which border the northern shore of Bantry Bay. The site is a Special Protection Area (SPA) under the E.U. Birds Directive, of special conservation interest for Chough and Fulmar. In addition the presence of Peregrine falcon is of particular significance.</p> <p><b>Sheeps Head to Toe Head SPA (Site Code: 004156)</b> large site situated on the south-west coast of Co. Cork. Adjacent Bantry Bay the site includes sea cliffs, the land adjacent to the cliff edge and is one of the most important sites in the country for Chough. The presence of Peregrine falcon is of particular significance.</p>

## Bantry Bay Screening

<p><b>Assessment criteria</b></p>	
<p>Describe the individual elements of the project (either alone or in combination with other plans or projects) likely to give rise to impacts on the Natura 2000 site.</p>	<p>Oysters, clams, abalone, urchins, scallop, mussels and finfish are cultured in Bantry Bay. In addition, there are applications to culture macroalgae (Kelp).</p> <p>Oyster culture is carried out using bags and trestles in the intertidal zone. The trestles are arranged in rows along the shore to maximise water movement over the oysters in the bags.</p> <p>Intertidal clam culture is carried out on mud and sand flats by placing the smaller seed clams in boxes of sediment and covered by mesh. As they grow the clams are spread directly into the sediment and covered by netting to prevent predation.</p> <p>Abalone and urchins are cultured in tanks on land or in cage structures in the lower intertidal and subtidal areas. They are contained at all times.</p> <p>The mussels are cultured using longlines. A long-line supported by a series of small floats joined by a cable or chain and anchored at the bottom on both ends is employed. Mussel spat (ssed) is collected on ropes or strings (droppers) are suspended on the line. From each of the lines there are a number of dropper lines (up to 5m in length). The depth of the droppers, which is directly related to the quantity of mussels being cultured, is dependant upon a number of factors including water depth, the floatation provided and the carrying capacity of the system.</p> <p>Scallops are culture intensively (bags suspended from longlines) and extensively (spread on the seafloor and harvest via dredging and/or diving).</p> <p>Finfish are contained in floating cage structures arranged in a grid system, which are secured to the seabed via ropes attached to anchors. Finfish are imputed into the cages as smolts and following a period of 18-24 months are harvested.</p> <p>Kelp is cultured using longlines supported by floating structures similar to those used for mussel culture.</p>
<p>Describe any likely direct, indirect or secondary impacts of the project (either alone or in combination with other plans or projects) on the Natura 2000 site by virtue of:</p>	
<p>size and scale;</p>	<p>There are no direct or indirect impacts from the culture operations on any of the SACs or SPAs adjacent to outer</p>

## Bantry Bay Screening

	Bantry Bay.
Distance from the Natura 2000 site or key features of the site:	The activities in question occur within outer Bantry Bay the mouth of which is adjacent to the Sheeps Head cSAC, the Glengarriff Harbour and Woodland SAC, the Beara Peninsula SPA and Sheep's Head to Toe Head SPA (see Figure 1).
Resource requirements (water abstraction etc.):	<p>Cultured bivalves (oysters, clams, scallops and mussels) are filter feeders and they feed upon suspended particulate matter. They selectively ingest phytoplankton and other organic material (e.g. small zooplankton and bacteria) and dispose of inorganic and larger organic matter in pseudofeces, which is excreted into the water column. Typically the fecal and pseudofecal pellets will fall to the sea floor and may cause localised organic enrichment and/or sedimentation. The level of enrichment is a function of, <i>inter alia</i>, water depth current speed, density of culture, the quantity of suspended particulate matter in the water column, or a combination of these. The shellfish production activities do not use any resources required by the qualifying features within the Natura 2000 sites.</p> <p>Abalone and urchin culture are carried out in contained systems and rely on the input of feed (usually seaweed sourced locally). The production of these shellfish species does not use any resources required by the qualifying features within the Natura 2000 sites</p> <p>Finfish culture differs from shellfish culture in that there is an input of feed into the system and as a consequence a net input of organic matter to the system. This material will be found in the system in the form of waste feed (on the seafloor), solid waste (faeces), waste as a consequence of net-cleaning all of which usually accumulates on the seafloor and dissolved material (predominantly fractions rich in nitrogen). For the most part, the majority of organic material builds up on the seabed generally in and around the footprint of the salmon cages with a 'halo' effect evident in areas where dispersion occurs driven by local hydrographic conditions. This is typically referred to as <i>near-field</i> effects. Similar to shellfish, the quantity of material that might accumulate on the seabed will be a function of the quantity of fish held in cages, the stage of culture, the health of the fish (unhealthy fish will generally eat less), husbandry practices (are the fish fed too much too quickly?), the physical characteristic of the solid particles and surrounding hydrographic conditions. The production of finfish does not use any resources required by the qualifying features within the Natura 2000 sites</p> <p>The culture of kelp is reliant upon ambient nutrient levels in the water column and solar illumination. The production of Kelp does not use any resources required by the qualifying features of adjacent Natura sites.</p>

## Bantry Bay Screening

Emissions (disposal to land, water or air):	There will be no direct or indirect effects on the adjacent Natura 2000 site.
Excavation requirements:	There are no excavation or similar activities associated with the aquaculture activity
Transportation requirements:	The produced aquaculture products are transported offsite by lorry using the existing national road network with no impact on the adjoining Natura 2000 sites.
Duration of construction, operation, decommissioning:	None
Other:	None

Describe any likely changes to the site arising as a result of:	
Reduction of habitat area:	There is no reduction in habitat area within any of the Natura 2000 sites considered arising from the shellfish production activities.
Disturbance to key species:	There is no evidence in the scientific literature to suggest that aquaculture activities impact on seal species (Feature of Glengarrif Harbour and Woodlands SAC) and the bird species listed in the SPAs, i.e., Chough, Fulmar and Peregrine. Furthermore, any impacts on habitats are likely to be local and not extend beyond the footprint of the activities. Therefore they are not likely to impact on any of the adjacent SACs.
Habitat or species fragmentation:	There is no habitat or species fragmentation within the Natura 2000 sites arising from the aquaculture production activities.
Reduction in species density:	There is no reduction in species density within the Natura 2000 sites arising from the shellfish production activities.
Changes in key indicators of conservation value (water quality):	There are no changes in key indicators of conservation value within the Natura 2000 sites arising from the shellfish production activities.
Climate change:	Given the nature and scale of the aquaculture production activities the contribution to climate change is considered insignificant.

## Bantry Bay Screening

Describe any likely impacts on the Natura 2000 site as a whole in term of;	
Interference with the key relationships that define the structure of the site:	None of the activities associated with the shellfish and finfish production in outer Bantry Bay will interfere with the key relationships that define the structure of the adjacent Natura 2000 sites.
Provide indicators of significance as a result of the identification of effects set out above in terms of:	None identified
None identified:	None identified
Fragmentation:	None identified
Disruption:	None identified
Disturbance:	None identified
Change to key elements of the site (e.g. water quality etc.):	None identified
Describe from the above those elements of the project or plan, or combination of elements, where the above impacts are likely to be significant or where the scale or magnitude of impacts is not known.	None identified

## Bantry Bay Screening

<b>Finding of no significance effect report:</b>	
Name of project or plan:	Aquaculture activities in outer Bantry Bay, Co. Cork.
Name and location of Natura 2000 site It would be helpful for a map or plan to be provided:	The Sheeps Head cSAC, the Glengarriff Harbour and Woodland SAC, the Beara Peninsula SPA and the Sheeps Head to Toe Head SPA, (Figure 1).
Description of the project or plan	The plan is to licence the shellfish and fish culture activity in Bantry Bay, Co. Cork. The activities in question cover approx. 547 ha. in total, representing approximately 1.2% of the surface area of Bantry Bay.
Is the project or plan directly connected with or necessary to the management of the site (provide details)?	No.
Are there other projects or plans that together with the project or plan being assessed could affect the site (provide details)?	No.
Describe how the project or plan (alone or in combination) is likely to affect the Natura 2000 site.	The cultivation of shellfish, finfish and macroalgae in outer Bantry Bay is not likely to affect the features of adjoining Natura 2000 sites.
Explain why these effects are not considered significant.	<p>There is no spatial overlap of the aquaculture activities with Natura sites. In addition, there would be no interference with key relationships that define the function of the sites. The culture activities will not result in habitat loss, there will not be significant disturbance to key species and there will be no habitat or species fragmentation. There will be no direct discharge of pollutants into the environment during the works and water quality will not be affected. Consequently, it is concluded that the culture of shellfish and finfish, as it is currently constituted and proposed, in Bantry Bay does not pose significant risk to the conservation features of the adjacent sites and as such does not require a full appropriate assessment.</p> <p>On the basis of the above it is considered that there will be <b><u>no significant effects</u></b> on the qualifying interests' of the Natura 2000 sites.</p>
Who carried out the assessment?	Marine Institute

## Bantry Bay Screening

Figure 1. Aquaculture activities and Natura Sites within the region of Outer Bantry Bay, Co. Cork.

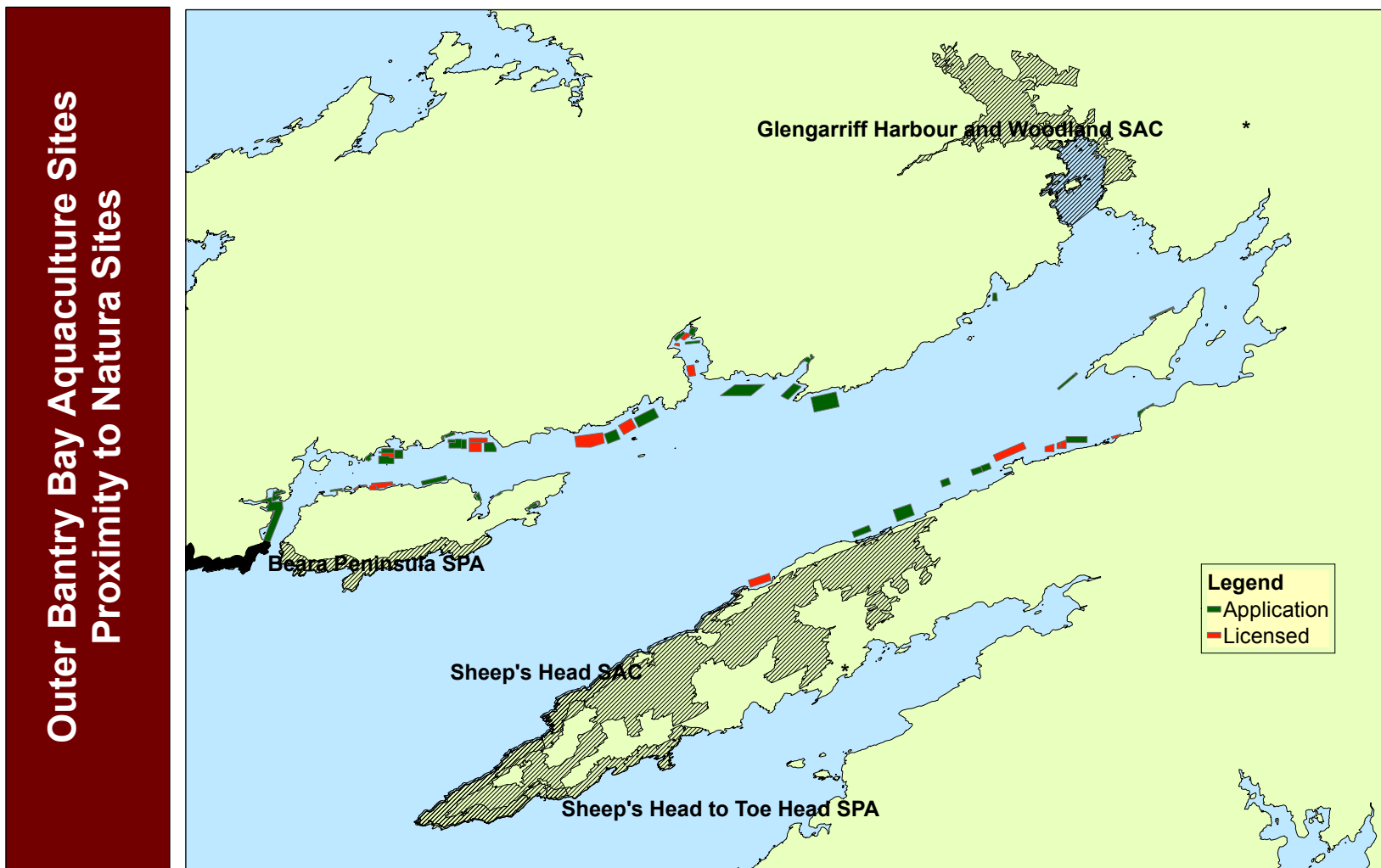





**T05/430A**

**AQUACULTURE LICENCE**

**AQUACULTURE MARINE**  
**SHELLFISH LONGLINES**

**West Cork Seafoods Ltd,**  
**Dromleigh South,**  
**Bantry,**  
**Co. Cork**

## **TABLE OF CONTENTS**

- 1. LICENSED AREA**
  - 2. SPECIES, CULTIVATION AND METHOD LICENSED**
  - 3. INFRASTRUCTURE AND SITE MANAGEMENT**
    - INDEMNITY
    - DESIGN, ARRANGEMENT AND MAINTENANCE OF STRUCTURES
    - OPERATIONAL CONDUCT
    - WASTE MANAGEMENT
    - INSPECTION
  - 4. NAVIGATION AND SAFETY**
  - 5. MONITORING**
  - 6. FISH HEALTH / MORTALITY MANAGEMENT / MOVEMENT OF FISH**
    - FISH HEALTH REGULATIONS
    - DISPOSAL OF MORTALITIES
    - MOVEMENT OF FISH
  - 7. DURATION, CESSATION, REVIEW, REVOCATION, AMENDMENT, ASSIGNMENT**
    - DURATION, CESSATION
    - REVIEW
    - REVOCATION, AMENDMENT
    - ASSIGNMENT
  - 8. FEES**
  - 9. GENERAL TERMS AND CONDITIONS**
    - NOTIFICATION
    - TAX CLEARANCE CERTIFICATE
    - COMPANIES AND CO-OPERATIVES
    - CLEARANCE OF SITE
- SCHEDULE 1*  
*SCHEDULE 2*  
*SCHEDULE 3*  
*SCHEDULE 4*

**T05/430A**

**AQUACULTURE LICENCE NO. XXXX**

**GRANTED UNDER THE FISHERIES (AMENDMENT) ACT 1997 (NO. 23 of 1997)**

The Minister for Agriculture, Food and the Marine (hereinafter referred to as the “Minister”), in exercise of the powers conferred on him by the Fisheries (Amendment) Act 1997 (No. 23 of 1997) (hereinafter referred to as the “Act”), hereby grants an Aquaculture Licence to:

**West Cork Seafoods Ltd,  
Dromleigh South,  
Bantry,  
Co. Cork**

(hereinafter referred to as the “Licensee”) for the cultivation of **mussels** on a site at **Glanlough along the south shore, Bantry Bay, Co. Cork** as specified in Schedule 1 attached (numbered **T005/430A**) and indicated by a red line on the attached map in accordance with the plans and drawing(s) in Schedule 2 attached as approved of by the Minister, subject to the Act and Regulations made under the Act and to the terms and conditions set out in the attached pages.

This Aquaculture Licence shall remain in force for a maximum period of **ten (10)** years commencing on **XX XXXXXXXXXXXX 20XX**, provided for so long as the Foreshore Licence granted on **XX XXXXXXXXXXXX 20XX**, under section 3(1) of the Foreshore Act 1933 (No. 12 of 1933) in respect of the same site for the purpose referred to is in force.

---

A person authorised under Section 15(1)  
of the Ministers and Secretaries Act 1924 to  
authenticate the Seal of the Minister for  
Agriculture, Food and the Marine.

## TERMS AND CONDITIONS APPLYING TO THIS AQUACULTURE LICENCE

### 1. Licensed Area

- 1.1. The area specified in *Schedule 1* attached (24.2029 hectares) (labelled T05/430A) and outlined in red on the map(s) in *Schedule 1*.
- 1.2. The co-ordinates for the site are based on the Irish National Grid Co-ordinate System.

### 2. Species, Cultivation and Method Licensed

- 2.1. Species to be farmed: Blue Mussel (*mytilus edulis*)
- 2.2. Method: Longlines – Suspended Rope Culture subject to the stocking and/or deployment limits as may be specified in *Schedule 4* attached.
- 2.3. The introduction of seed to the site shall comply with the legislation relating to fish health, except in the case of rope mussel farming where a natural mussel spat collection system is being applied.

### 3. Infrastructure and Site Management

#### Indemnity

- 3.1. The Licensee shall indemnify and keep indemnified the State, the Minister, his officers, servants or agents against all actions, loss, damage, costs, expenses and any demands or claims however arising in connection with the construction, maintenance or use of any structures, apparatus, equipment or any other thing used in connection with the licensed operation in the licensed area or in the exercise of the rights granted under the licence and the Licensee shall take such steps as the Minister may specify in order to ensure compliance with this condition.
- 3.2. The duty of maintenance and responsibility for the upkeep and safety of the site rests with the Licensee.

#### Design, Arrangement and Maintenance of Structures

- 3.3. The Licensee shall ensure that the equipment (including all flotation, mooring and anchoring devices) is placed within the licensed area only. Storage or placement of equipment or stock on the foreshore or seashore outside the licensed area is not permitted under any circumstances.
- 3.4. The Minister may direct as to the deployment of apparatus, including number or orientation of longlines and flotation devices and their colour, within the site.
- 3.5. The Licensee shall obtain the prior approval of the Minister to any proposed material change to the plan/drawings or equipment as approved being used during the licensing period as specified in *Schedule 2* attached.

- 3.6. The Licensee shall at all times for the duration of the licence keep all equipment used for the purposes of the licensed operations in a good and proper state of repair and condition to the satisfaction of the Minister or other competent State authority.
- 3.7. The Licensee shall ensure that the ends of each longline in the licensed area legibly bear the Aquaculture Licence Number in an indelible weatherproof format.

#### Operational Conduct

- 3.8. The Licensee shall conduct its operations in a safe manner and with regard for other persons in the area and the environment and shall ensure that the operations are not injurious to adjacent lands or the public interest (including the environment) and do not interfere with navigation or other lawful activity in the vicinity of the licensed area, and shall comply with any lawful directions issued by the Minister and any other competent State authority in that regard.
- 3.9. The Licensee shall ensure that any aquaculture or other activity conducted under this licence does not adversely affect the integrity of the Natura 2000 network (if applicable) through the deterioration of natural habitats and the habitats of species and/or through disturbance of the species for which the area has been designated in so far as such a disturbance may be significant in relation to the stated conservation objectives of the site concerned.
- 3.10. The Licensee shall ensure that best practice is employed to keep structures and netting clean at all times and any biofouling by alien invasive species shall be removed and disposed of in a responsible manner. In particular, in 'Natura 2000' sites care must be taken to ensure that any biofouling by alien invasive species will not pose a risk to the conservation features of the site. Measures to be undertaken are set out in the draft Marine Code of Practice prepared by Invasive Species Ireland and can be found on the web site at: <http://invasivespeciesireland.com/>.

#### Waste Management

- 3.11. The Licensee shall ensure that the licensed and adjoining areas shall be kept clear of all redundant structures (including apparatus, equipment and/or uncontained stock), waste products and operational litter or debris and shall make provision for the prompt removal and proper disposal of such material. If the Licensee refuses or fails to do so, the Minister may cause the said structures, apparatus, equipment or other thing to be removed and the licensed area restored and shall be entitled to recover from the Licensee as a simple contract debt in any court of competent jurisdiction all costs and expenses incurred by him in connection with the removal and restoration.

#### Inspection

- 3.12. The licensed area and any equipment, structure, thing, or premises wherever situated used in connection with operations carried out in the licensed area shall be open for inspection at any time by an authorised person (within the meaning of section 292 of the Fisheries (Consolidation) Act 1959) (No. 14 of 1959) (as amended by the Fisheries Act 1980) (No. 1 of 1980), a Sea Fisheries Protection Officer (within the meaning of the Sea Fisheries and Maritime Jurisdiction Act 2006) (No. 8 of 2006) or any other person appointed in that regard by the Minister or other competent State authority.

- 3.13. The Licensee shall give all reasonable assistance to an authorised officer or a Sea Fisheries Protection Officer or any person duly appointed by any competent State authority to enable the person or officer enter, inspect, examine, measure and test the licensed area and any equipment, structure, thing or premises used in connection with the operations carried out in the licensed area and to take whatever samples may be deemed appropriate by that person or officer.
- 3.14. The Licensee shall keep and maintain in the State for inspection on demand by the Minister or a competent State authority, at all times, records of all operations including compliance monitoring and any required follow up action. These records shall be produced by the Licensee on demand by the Minister or other competent State authority and in any event not later than 24 hours from the making of that demand.
- 3.15. The Licensee shall furnish to the Minister or other competent State authority in the form and at the intervals determined by the Minister or other competent State authority, such information relating to the licensed area as may be required to determine compliance by the Licensee with the terms of this licence and applicable legislation.

#### **4. Navigation and Safety**

- 4.1. The Licensee shall ensure that statutory sanction from the Commissioners of Irish Lights is in place prior to the commencement of operations, regarding all aids to navigation. Statutory Sanction forms are available at <http://www.cil.ie/safety-navigation/statutory-sanction.aspx>.
- 4.2. The Licensee shall ensure that the site is marked in accordance with the requirements of both the Marine Survey Office and the Commissioners of Irish Lights as specified in *Schedule 3*.
- 4.3. The Licensee shall comply with any specification requirement relating to navigational aids, flotation and mooring devices, supporting/marking posts/poles, as required by the Minister or any other competent State authority.
- 4.4. The Minister's determination in respect of this licence is conditional upon immediate full compliance by the Licensee in respect of all requirements and conditions which are imposed under the relevant legal provisions applicable to the Marine Survey Office.
- 4.5. Prior to commencement of operation the Licensee shall inform the UK Hydrographic Office at Taunton, of the location and nature of the site in order that charts and nautical publications can be updated. Tel: 00 44 1823337900 Fax: 00 44 1823 284077 Email [sdr@ukho.gov.uk](mailto:sdr@ukho.gov.uk) and the Licensee shall submit proof to the Department within 14 days of the date of this licence that the UK Hydrographic Office has been so informed.

#### **5. Monitoring**

5.1. The Licensee shall undertake and/or partake in monitoring, in particular environmental monitoring, as directed by the Minister or other competent State authority.

**6. Fish Health / Mortality Management / Movement of Fish**

Fish Health Regulations

6.1. Before the site is stocked the Licensee shall ensure that a Fish Health Authorisation under statutory provisions giving effect to Council Directive No. 2006/88/EC, as amended, or any other legislative act that replaces that Directive on animal health requirements for aquaculture animals and their products, and on the prevention and control of certain diseases in aquatic animals, is in place.

Disposal of Mortalities

6.2. The Licensee shall dispose of dead fish in accordance with the applicable statutory provisions and requirements.

Movement of Fish

6.3. The Licensee shall comply with any regulations in force governing the movement of fish.

**7. Duration, Cessation, Review, Revocation, Amendment, Assignment**

Duration, Cessation

7.1. This Licence shall remain in force until ~~XX XXXXXXXX~~, 20XX and as long as the accompanying Foreshore Licence remains in force.

Review

7.2. The Licensee may apply for a review of the licence at any time after the expiration of three years since the granting of the licence or its last renewal in accordance with section 70 of the Act.

Revocation, Amendment

7.3. Subject to the Act, the Minister may revoke or amend the licence if:–

- (a) he considers that it is in the public interest to do so,
- (b) he is satisfied that there has been a breach of any condition specified in the licence e.g., operating outside the licensed area,
- (c) the licensed area to which the licence relates is not being properly maintained,
- (d) water quality results or general performance in the licensed area do not meet the standards set by the Minister or the competent State authority.

Assignment

7.4. This Licence shall not be assigned without the prior written consent of the Minister and may not be assigned during the period of three years, dating from the commencement or renewal of this licence, unless the Minister determines that it may be assigned under condition 7(5) or the condition set out in 7(6) applies.

7.5. A Licensee, who considers that there are exceptional reasons for the assignment of the Licence during the first three years, may apply to the Minister, giving those

reasons, for a determination that the Licence may be assigned. The Minister may, at his discretion, having considered the reasons given by the Licensee, determine whether or not the Licence may be assigned. The determination of the Minister in this regard is final.

7.6. Where the Licensee is a company (within the meaning of the Companies Acts) and goes into Liquidation (within the meaning of the Companies Acts) in the first three years dating from the commencement of the licence, the Liquidator shall, with the consent of the Minister, be entitled to assign the licence to enable him to discharge any debts of the liquidated company.

7.7. This licence is issued subject to any order that the High Court may make under section 218 of the Companies Act 1963 or otherwise with regard to the assignment of this licence.

## **8. Fees**

8.1. The Licensee shall pay to the Minister an annual aquaculture licence fee in accordance with the Aquaculture (Licence Application and Licence Fees) Regulations 1998 (S.I. No. 270/1998) as amended by the Aquaculture (Licence Fees) Regulations 2000 (S.I. No. 282 of 2000) or an amount payable under Regulations made under section 64 of the Act.

8.2. The Minister may revoke the licence where the Licensee fails to pay the aquaculture licence fees on demand.

## **9. General Terms and Conditions**

9.1. The Licensee shall at all times comply with all laws and protocols applicable to aquaculture operations.

9.2. Any reference to a statute or an act of an institution of the European Union (whether specifically named or not) includes any amendments or re-enactments in force and all statutory instruments, orders, notices, regulations, directions, bye-laws, certificates, permissions and plans made, issued or given effect under such legislation shall remain valid.

9.3. If any condition or part of a condition in this licence is held to be illegal or unenforceable in whole or in part, such condition shall be deemed not to form part of this licence but the enforceability of the remainder of this licence is not affected.

9.4. The Licensee shall at all times hold all necessary licences, consents, permissions, permits or authorisations associated with any activities of the Licensee in connection with the licensed area.

### Notification

9.5. Without prejudice to any other remedy under the licence or in law, if the Minister is of the view that the Licensee is in breach of any obligation under this licence, the Minister may, by notice in writing, require that the Licensee rectifies such breach,



within such time as is specified by the Minister. The Licensee shall comply with any direction of the Minister within the time specified in the notice.

9.6. Any notice to be given by the Minister may be transmitted through the Post Office addressed to the Licensee at the last known address of the Licensee.

9.7. The Licensee shall notify the Minister within 7 days of any change in the Licensee's address, telephone, e-mail or facsimile number.

#### Tax Clearance Certificate

9.8. During the term of this licence the Licensee shall provide to the Minister on demand a current tax clearance certificate.

#### Companies and Co-operatives

9.9. In the event of the licence being granted to a company (within the meaning of the Companies Acts), control of the licensee company shall not change in any respect from the control of the company as existed on the date that the licence was granted so long as this licence shall remain in force save with the prior written permission of the Minister.

9.10. In the event of a licence being granted to a company that has been incorporated outside this State, the licensee company shall register with the Companies Registration Office within one month of the establishment of a place of business in the State or alternatively, within one month of the establishment of a branch of the said company in the State and the licensee company shall submit proof to the Department within 14 days of the end of that month that it has been so registered.

9.11. Where the licensee is a Company within the meaning of the Companies Acts, the licensee company shall ensure that it does not become dissolved within the meaning of the Companies Acts for so long as this licence shall remain in force.

9.12. In the event of the licence being granted to a society (within the meaning of section 2 of the Industrial and Provident Societies (Amendment) Act 1978 (No.23 of 1978) the following conditions shall apply:-

9.12.1 The rules relating to membership of the society shall enable any resident of the State to become a member of it where the resident fulfils all the conditions laid down by the society for membership of it and the rules shall not lay down different conditions for different classes of people;

9.12.2 The rules relating to the society as submitted to the Minister before the grant of this licence shall not be amended subsequently other than with the written permission of the Minister; and

9.12.3 The Minister may, if he considers it necessary in the interests of good management of the licensed area, direct that an amendment may be made to the rules of the society and the Licensee shall amend the rules in accordance with that direction.

#### Clearance of Site

9.13. The Licensee shall, at the Licensee's own expense, if so required by written notice from the Minister and within three weeks after receipt of such notice or on cessation of the licence for any other cause, remove the structures, apparatus, equipment or any other thing to the satisfaction of the Minister. If the Licensee refuses or fails to do so, the Minister may cause the said structures, apparatus, equipment or other thing to be removed and the licensed area restored and shall be entitled to recover from the Licensee as a simple contract debt in any court of competent jurisdiction all costs and expenses incurred by him in connection with the removal and restoration. The Licensee shall take such steps as the Minister may specify in order to secure compliance with this condition.

DRAFT

## **SCHEDULE 1**

**Schedule 1 contains:**

- **the co-ordinates of the site based on the Irish National Grid Co-ordinate System and the area of the site**
- **site map(s)**
- **a chart showing the location of the site in relation to the surrounding area.**

**DRAFT**

**1 NO. SITE AT BANTRY BAY CO.CORK**

**Co-ordinates & Area**

**Site T05/430A (24.2029 Ha)**

The area seaward of the high water mark and enclosed by a line drawn from Irish National Grid Reference point

087601, 043679 to Irish National Grid Reference point  
087464, 044065 to Irish National Grid Reference point  
088040, 044266 to Irish National Grid Reference point  
088168, 043903 to the first mentioned point.

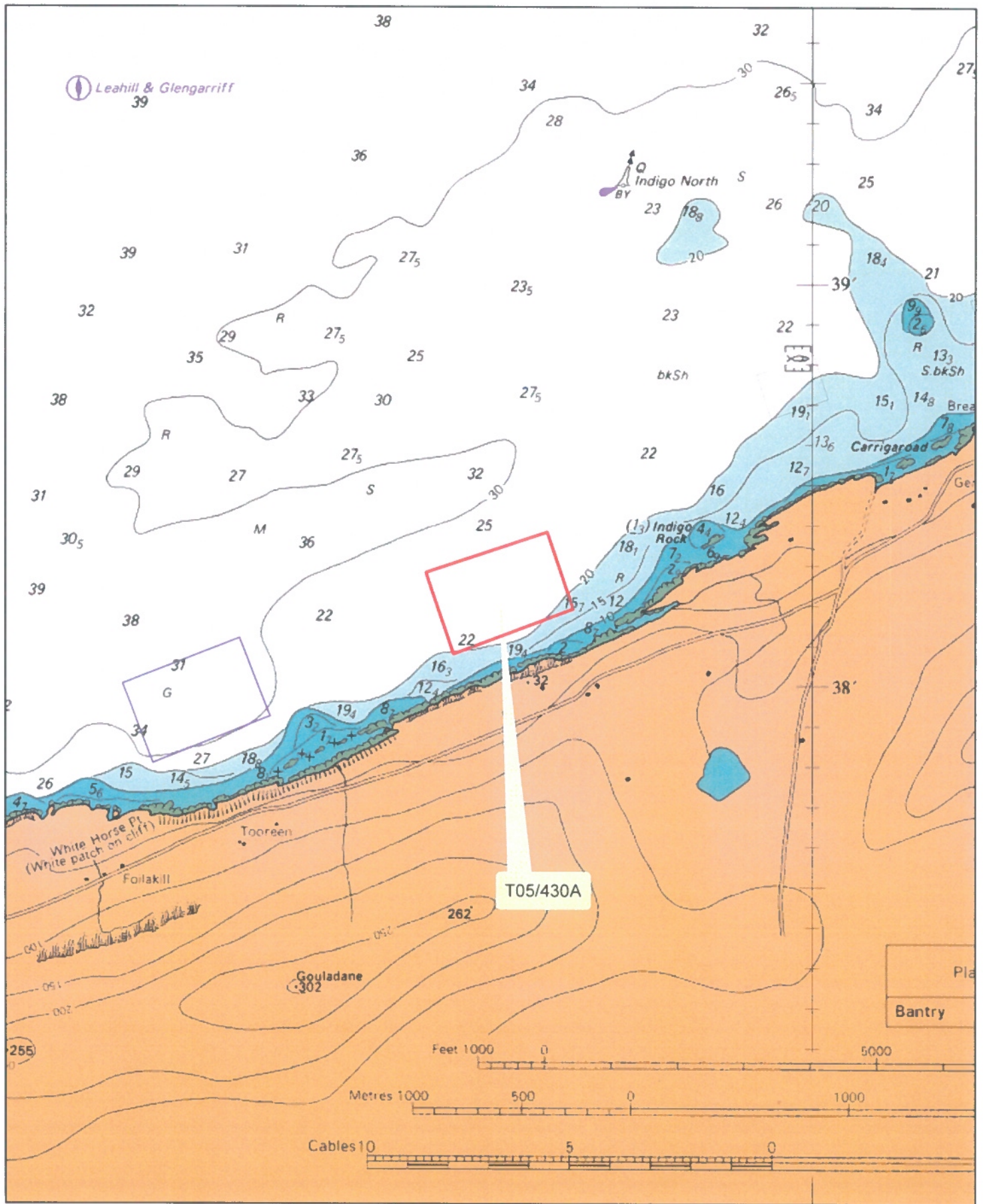

- Aqua Culture Sites**  
 <all other values>
- Site\_Status**
- Under Appeal
  - Application
  - Lapsed
  - Licensed
  - Refused
  - Revoked
  - Surrendered
  - Withdrawn

**1:24,000**

Sites highlighted in red denotes Application

Part of Admiralty Chart No =1838-0  
 Not to be used for Navigation



**An Roinn Talmhaíochta,  
 Bia agus Mara**  
 Department of Agriculture,  
 Food and the Marine

88000

89000

44000

44000

43000

43000

88000

89000



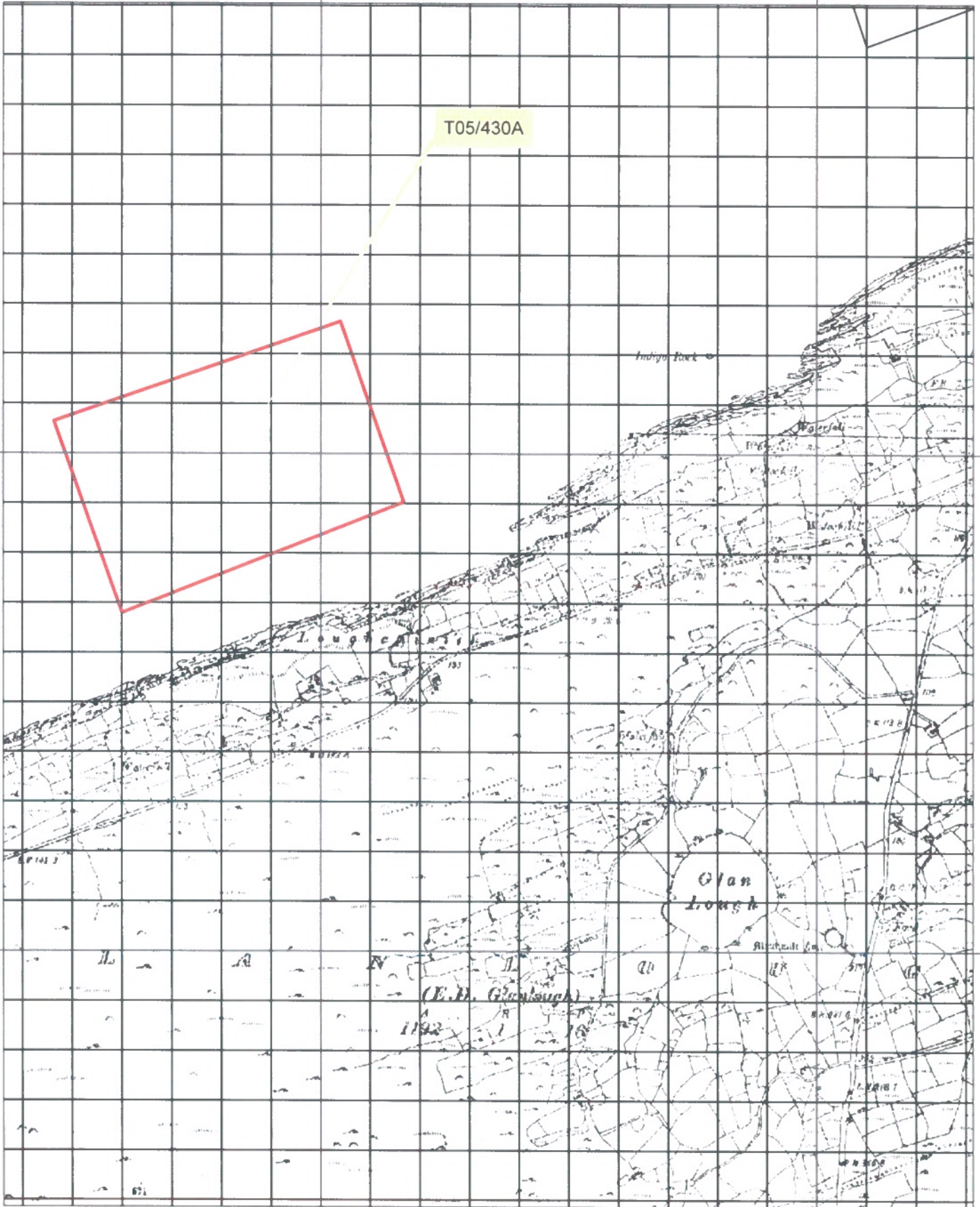





T05/430A



**Aqua Culture Sites**

<all other values>

**Site\_Status**

-  Under Appeal
-  Application
-  Lapsed
-  Licensed
-  Refused
-  Revoked
-  Sumendered
-  Withdrawn
-  100 Meter Reference Grid

1:10,560

Sites highlighted in red denotes Application

Ordnance Survey Ireland Licence No. EN 0076418  
© Ordnance Survey Ireland/Government of Ireland



**An Roinn Talmhaíochta,  
Bia agus Mara**  
Department of Agriculture,  
Food and the Marine

## **SCHEDULE 2**

**Schedule 2 contains:**

- **the approved plans and drawing(s)**

**DRAFT**

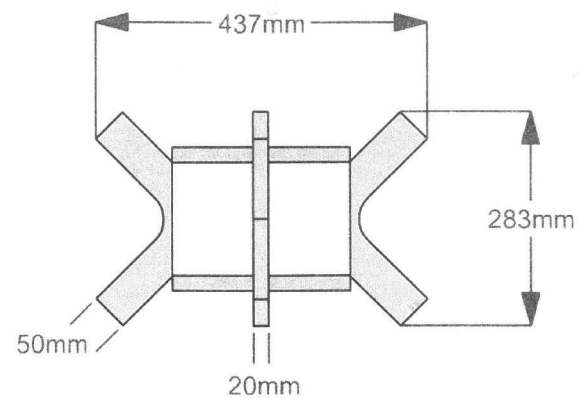

SIDE ELEVATION :  
SPECIAL MARK BEACON

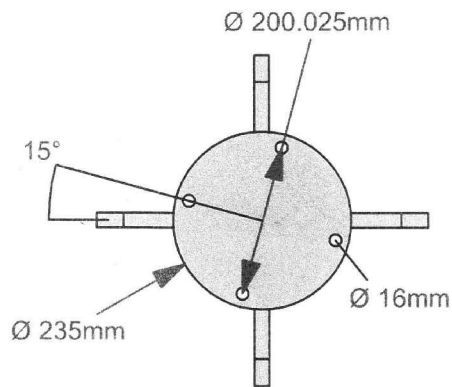

PLAN :  
SPECIAL MARK BEACON

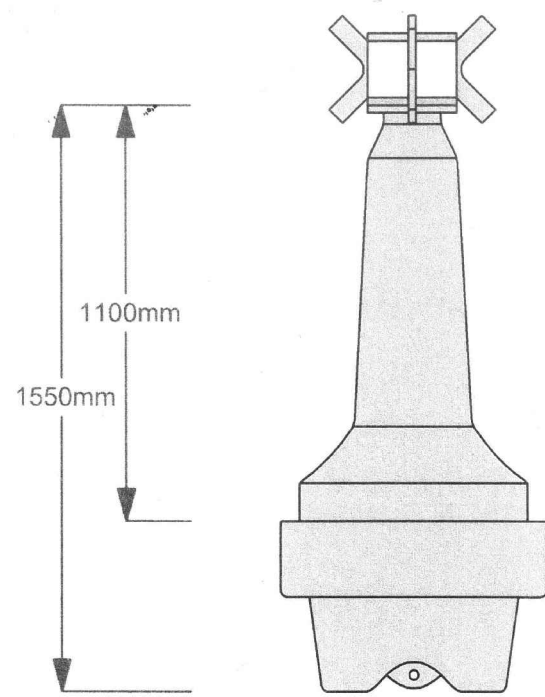

ELEVATION :  
FLOATING MARKER BUOY  
SCALE 1:20

Floating Marker Buoy Specification

- Total Height 1550mm
- Total Weight 65kg
- Diameter 600mm
- Volume 189 Litres
- Focal View 1100mm
- Mooring Ring Diameter 25mm
- Mooring block & line suitable for location

## Floating Marker Buoy Detail 1:10 & 1:20

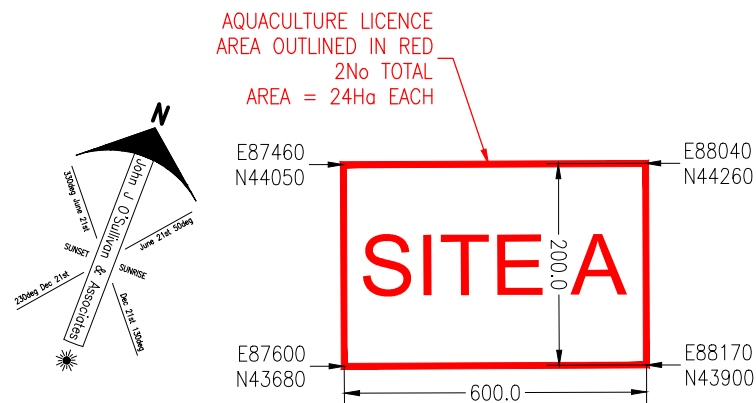

## Orientation Layout 1:15,000

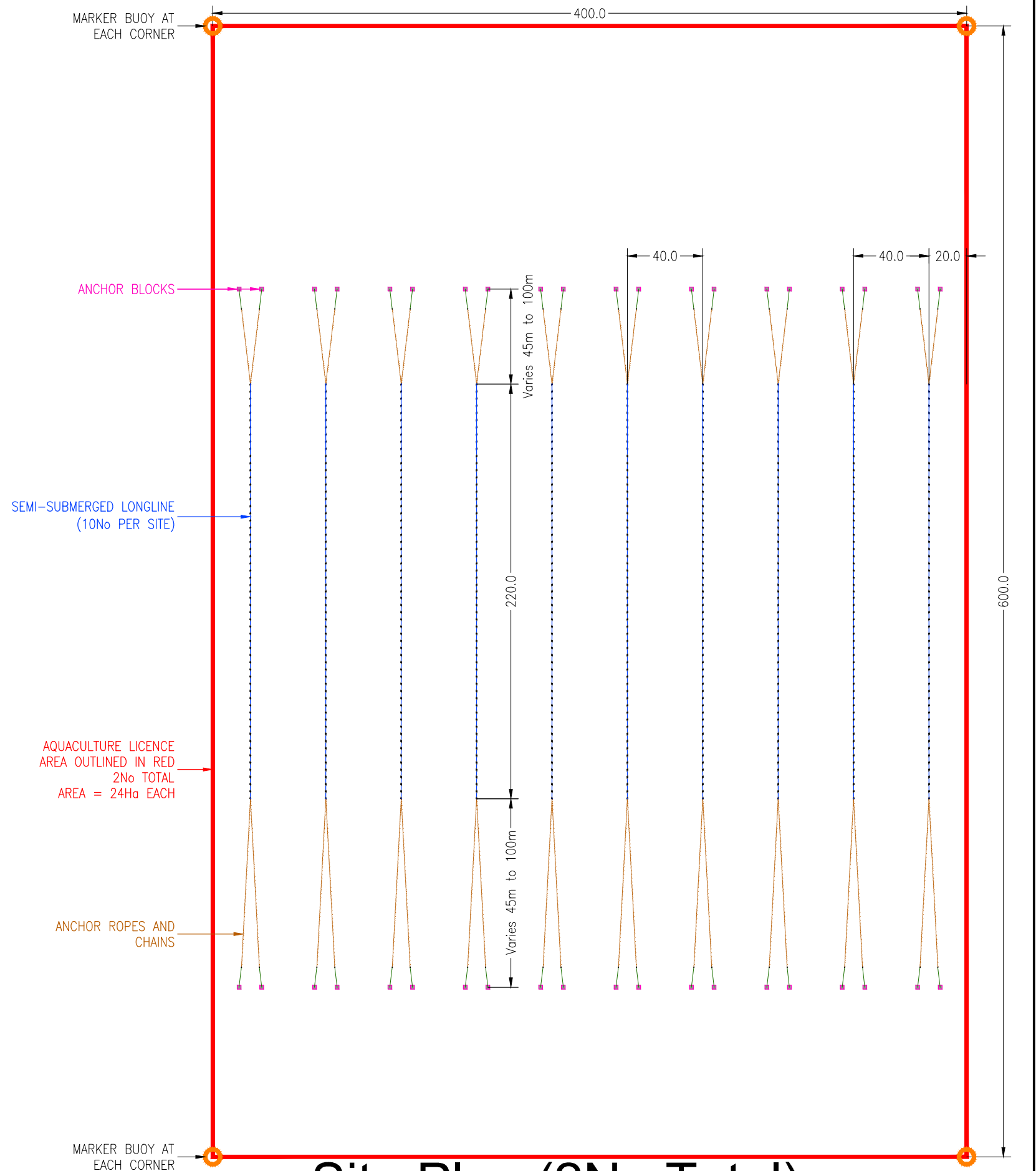

## Site Plan (2No Total) 1:2,500

Client: WEST CORK SEAFOODS LTD

Project: AQUACULTURE LICENCE APPLICATION,  
FOILAKILLY/GLANLOUGH, BANTRY BAY, CO. CORK

Drawing Status: ISSUE FOR AQUACULTURE LICENCE

Drawing Title: SEMI-SUBMERGED SINGLE HEADROPE LINE DETAILS

Scale: A3 - AS SHOWN

O.S.S. CK

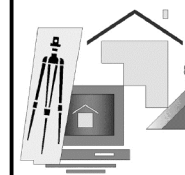

GLEN DESIGN PARTNERSHIP T/A

**JOHN J. O'SULLIVAN & ASSOCIATES**

• Planning & Architectural Consultants • Consulting Engineers & Surveyors •

'Lindhu', Reenmeen East, GLENGARRIFF, Co. Cork, P75 YX92 Ireland

• Tel: 027 63126 • Fax: 027 63557 • Office email: info@jjos.ie • Website: www.jjos.ie •

Drawn By: Gerard Harrington Arch Tech BSc

Checked By: John J. O'Sullivan, BE C.Eng. MIEI

Date: 31/01/2019

Dwg No: L00051902-00



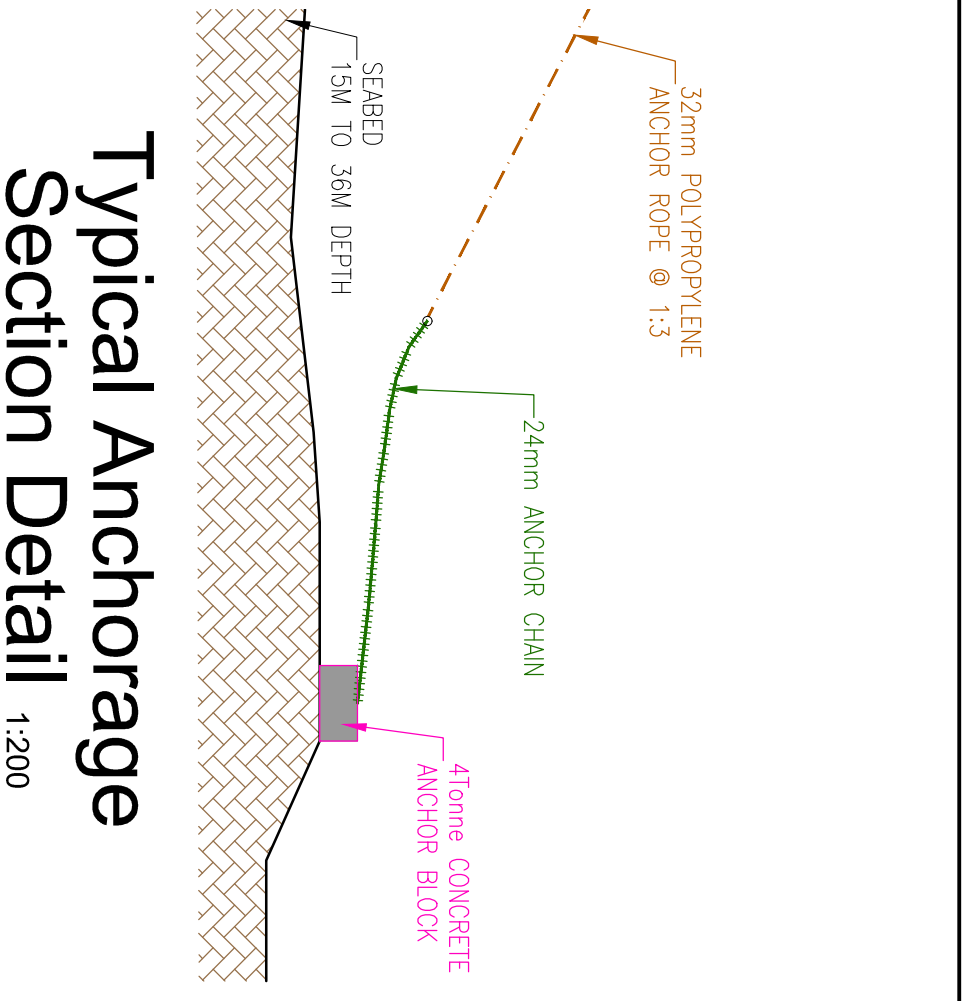
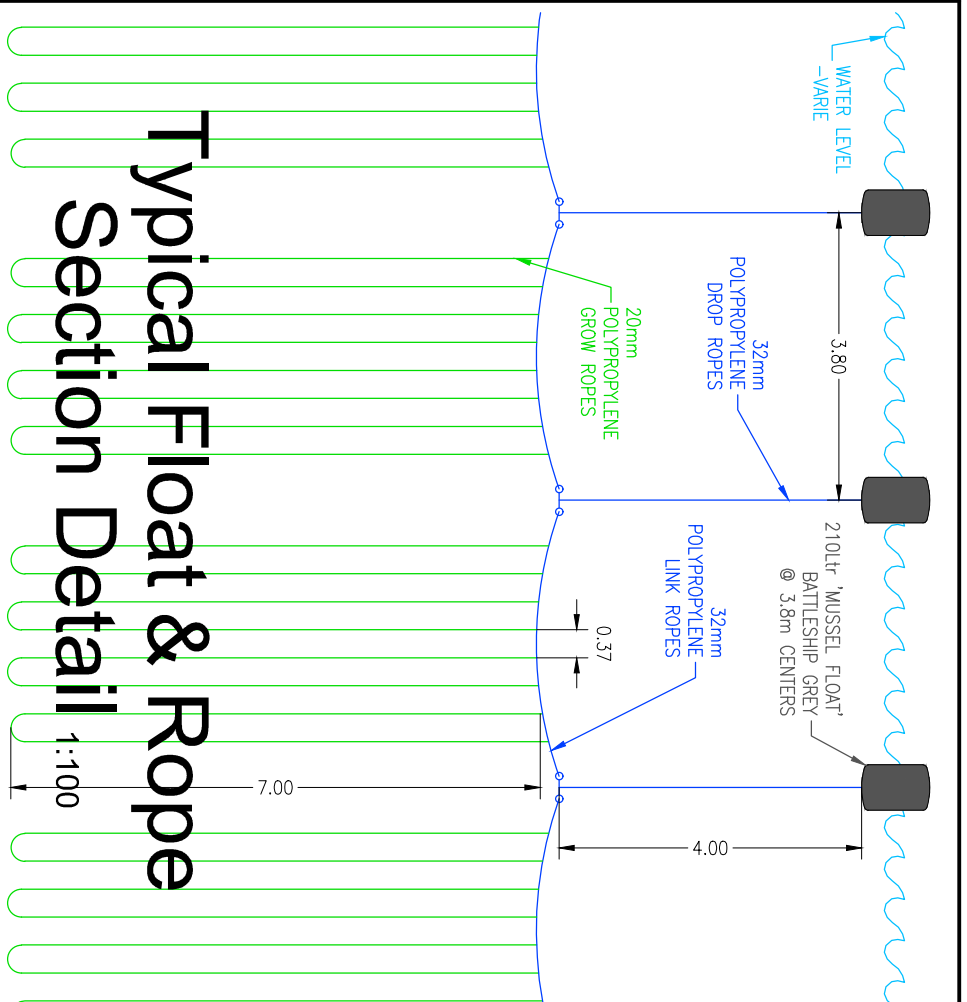
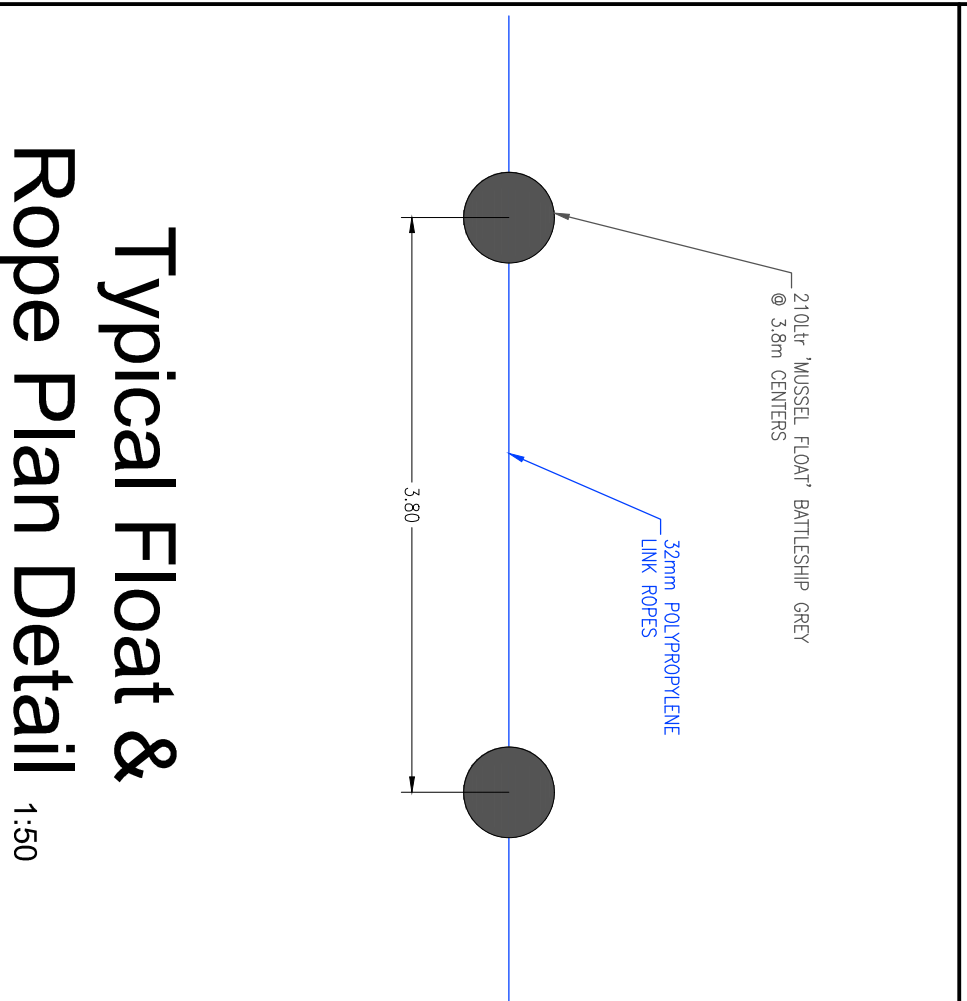
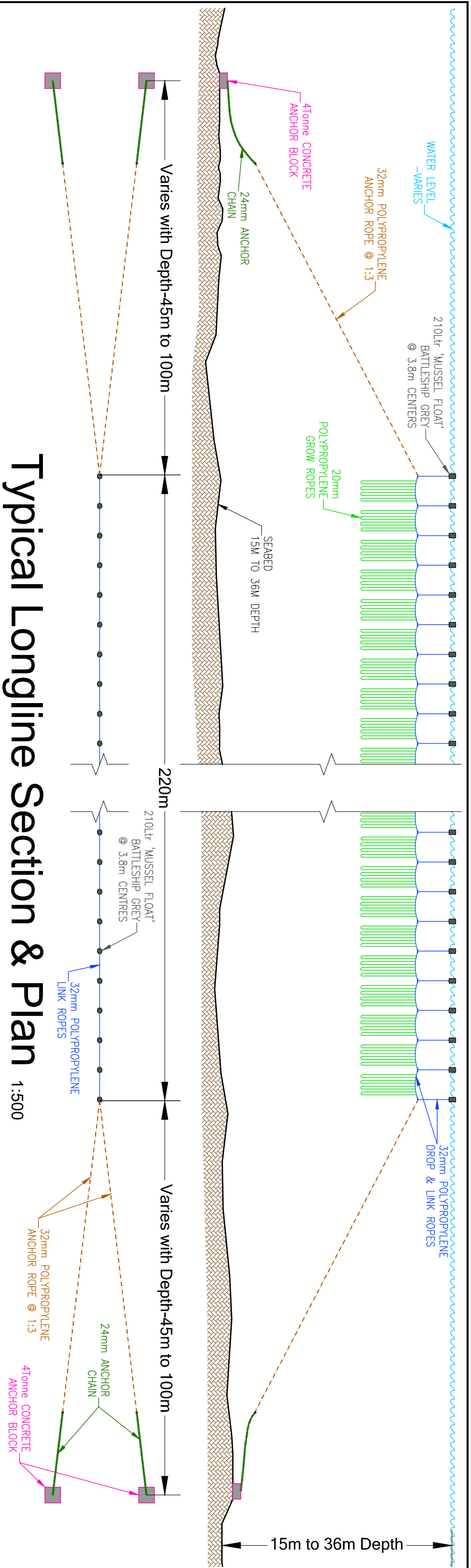

Client: WEST CORK SEAFOODS LTD  
 Project: AQUACULTURE LICENCE APPLICATION,  
 FOLLAKILLY/GLANLUGH, BANTRY BAY, CO. CORK

Drawing Status: ISSUE FOR AQUACULTURE LICENCE  
 Drawing Title: SEMI-SUBMERGED SINGLE HEADROPE LINE DETAILS  
 Scale: A3 - AS SHOWN  
 O.S.S. CK

GLEN DESIGN PARTNERSHIP T/A  
**JOHN J. O'SULLIVAN & ASSOCIATES**  
 Planning & Architectural Consultants - Consulting Engineers & Surveyors -  
 'Lindhu', Reenmeen East, GLENGARRIFF, Co. Cork, P75 YX92 Ireland  
 Tel: 027 63126 · Fax: 027 63557 · Office email: info@jjos.ie · Website: www.jjos.ie ·

Drawn By: Gerard Harrington Arch Tech BSc  
 Checked By: John J. O'Sullivan, BE C.Eng. MEl  
 Date: 31/01/2019  
 Dwg No.: L00051902-00

## SCHEDULE 3

Schedule 3 contains:

- requirements of the MSO and/or CIL
- **the navigation marking detail.**

All structures must be clearly marked as required by Regulations and Licensing Permit conditions and to the approval of the Nautical Surveyor with the Marine Survey Office.

DRAFT

## SCHEDULE 4

Schedule 4 contains conditions specific to this licence:

- **the stocking and/or equipment deployment conditions.**
1. The floatation barrels of the longlines should be battleship grey in colour.
  2. Each mussel longline will not be longer than 220 metres in length.
  3. Site access is from Gearhies Pier.
  4. The initial source of seed and other sources which may be used at any point in the future must be approved by the Minister.
  5. No non-native species to be used.
  6. Prior to the commencement of any aquaculture activity on this site, the applicant is required to prepare a Contingency Plan, for the approval of the Department of Agriculture, Food and The Marine, which should identify, inter alia, methods for the removal from the environment of any non-native species introduced as a result of operations at this site.
  7. The Licensee must contact their local Sea Fisheries Protection Authority Officer prior to harvesting of mussels from the site to commence a sampling regime which is required under the Sea Fisheries Protection Authority Code of Practice for the Microbiological Monitoring of Bivalve Mollusc Production as the site is located in an area not currently classified for the production of mussels.



**T05/430A**

**FORESHORE LICENCE**

**West Cork Seafoods Ltd,  
Dromleigh South,  
Bantry,  
Co. Cork**

## **TABLE OF CONTENTS**

**TERMS AND CONDITIONS APPLICABLE TO FORESHORE LICENCE**

SEAL OF OFFICE AND SIGNATURES

*SCHEDULE 1*

**DRAFT**

**FORESHORE LICENCE IN RESPECT OF A SITE**  
**(NUMBERED T05/430A) AT BANTRY BAY, CO. CORK**

AGREEMENT made on the **XX XXXXXXXX 20XX**, between the Minister for Agriculture, Food and the Marine (hereinafter referred to as the “Minister” which expression shall include his Successors or Assigns where the contract so requires or admits), of the one part, and

**WEST CORK SEAFOODS LTD,**  
**DROMLEIGH SOUTH,**  
**BANTRY,**  
**CO. CORK**

(hereinafter referred to as the “Licensee”) of the other part, whereby the Minister, in exercise of the powers conferred on him by Section 3 of the Foreshore Act, 1933 (No.12 of 1933) hereby grants to the Licensee licence to use and occupy that part of the foreshore at **Glanlough along the south shore, Bantry Bay, Co. Cork** (numbered **T05/430A**) detailed in the attached schedule and more particularly delineated on the map annexed hereto and thereon coloured red for the purpose of the cultivation set out in Aquaculture Licence Number **XXX** on the terms and conditions set out in the attached pages.

This Foreshore Licence shall remain in force for a maximum period of **ten (10)** years commencing on **XX XXXXXXXXXXXX 20XX**, provided for so long as the Aquaculture Licence Number **XXX** granted on **XX XXXXXXXX 20XX** under the Fisheries (Amendment) Act 1997 (No. 23 of 1997) in respect of the same site for the purpose referred to is in force.

## TERMS AND CONDITIONS APPLICABLE TO FORESHORE LICENCE

1. The Licensee shall pay to the Minister the annual sum of € XXXXX (XXXXX euro XXX cent), such payment to be made on the XX day of XXXXXXXXX in every year during the continuance of this Licence, the first of such payments to be made on the signing hereof.
2. The Licensee shall use that part of the foreshore, the subject matter of this Licence, for the cultivation set out in Aquaculture Licence Number XXX only and for no other purpose whatsoever.
3. The Licensee shall comply fully with all terms and conditions of Aquaculture Licence Number XXX.
4. The Licensee shall indemnify and keep indemnified the State, the Minister, his officers, servants or agents against all actions, loss, damage, costs, expenses and any demands or claims however arising in connection with the construction, maintenance or use of any structures, apparatus, equipment or any other thing used in connection with the licensed operation in the licensed area or in the exercise of the rights granted under the licence and the Licensee shall take such steps as the Minister may specify in order to ensure compliance with this condition.
5. The duty of maintenance and responsibility for the upkeep and safety of the site rests with the Licensee.
6. The Minister shall be at liberty at any time to terminate this Licence by giving to the Licensee three months notice in writing ending on any day, and upon determination of such notice, the Licence and permission granted shall be deemed to be revoked and withdrawn without the liability for the payment of any compensation by the Minister to the Licensee.
7. Any notice to be given by the Minister may be transmitted through the Post Office addressed to the Licensee at the last known address of the Licensee.
8. The Licensee shall not carry out any operations authorised by the Licence in the licensed area in such a manner as to interfere unreasonably with fishing or navigation in the vicinity of the licensed area and shall comply with any direction given to the Licensee in that regard by the Minister.
9. In the event of the breach, non-performance or non-observance by the Licensee of any of the conditions herein contained, the Minister may forthwith terminate this Licence without prior notice to the Licensee.

**AND IT IS HEREBY CERTIFIED THAT:**

1. For the purpose of the stamping of this Instrument that this is an Instrument to which the provisions of Section 53 of the Stamp Duties Consolidation Act 1999 (No. 31 of 1999), do not apply for the reason that the entire of the property involved comprises Foreshore and contains no Buildings.
2. The Family Law Acts of 1976, 1981, 1989, 1995 and the Family Law (Divorce) Act 1996 do not affect the Property.

**SEAL OF OFFICE AND SIGNATURES**

**PRESENT when the Seal of Office of the MINISTER FOR AGRICULTURE, FOOD AND THE MARINE was affixed and was authenticated by the Signature of:**

**WITNESS:** \_\_\_\_\_

**ADDRESS:** \_\_\_\_\_

**OCCUPATION: CIVIL SERVANT**

**SIGNED on behalf of Licensee**

**in the presence of:**

**WITNESS:** \_\_\_\_\_

**ADDRESS:** \_\_\_\_\_

**OCCUPATION:** \_\_\_\_\_

\_\_\_\_\_  
**A person so authorised under Section 15(1) of the Ministers and Secretaries Act, 1924 to authenticate the seal of the Minister.**

\_\_\_\_\_



## **SCHEDULE 1**

**Schedule 1 contains:**

- **the co-ordinates of the site based on the Irish National Grid Co-ordinate System and the area of the site**
- **site map(s)**
- **a chart showing the location of the site in relation to the surrounding area.**

**DRAFT**

**1 NO. SITE AT BANTRY BAY CO.CORK**

**Co-ordinates & Area**

**Site T05/430A (24.2029 Ha)**

The area seaward of the high water mark and enclosed by a line drawn from Irish National Grid Reference point

087601, 043679 to Irish National Grid Reference point  
087464, 044065 to Irish National Grid Reference point  
088040, 044266 to Irish National Grid Reference point  
088168, 043903 to the first mentioned point.

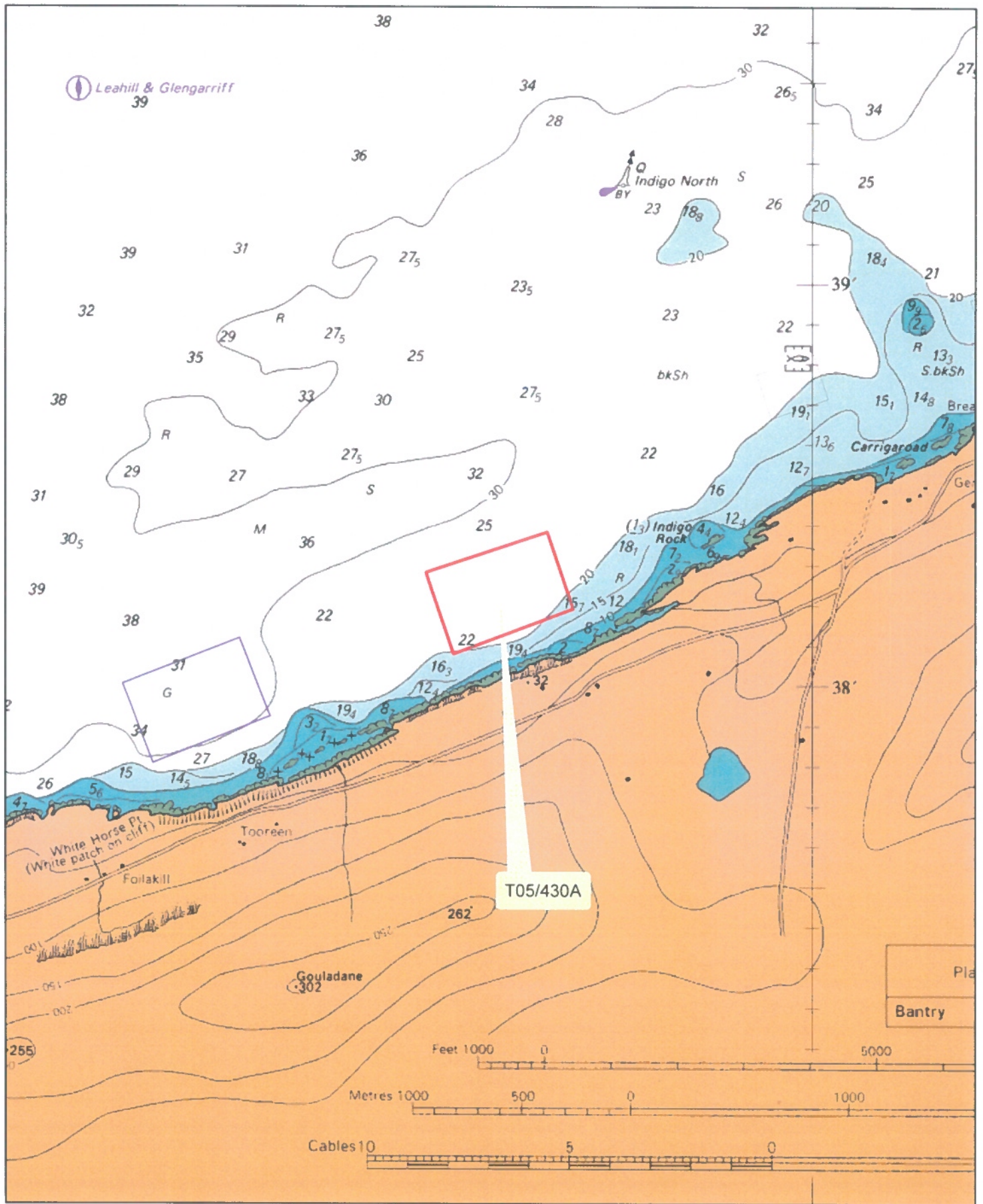

- Aqua Culture Sites**  
 <all other values>
- Site\_Status**
- Under Appeal
  - Application
  - Lapsed
  - Licensed
  - Refused
  - Revoked
  - Surrendered
  - Withdrawn

**1:24,000**

Sites highlighted in red denotes Application

Part of Admiralty Chart No =1838-0  
 Not to be used for Navigation



**An Roinn Talmhaíochta,  
 Bia agus Mara**  
 Department of Agriculture,  
 Food and the Marine

88000

89000

44000

44000

43000

43000

88000

89000



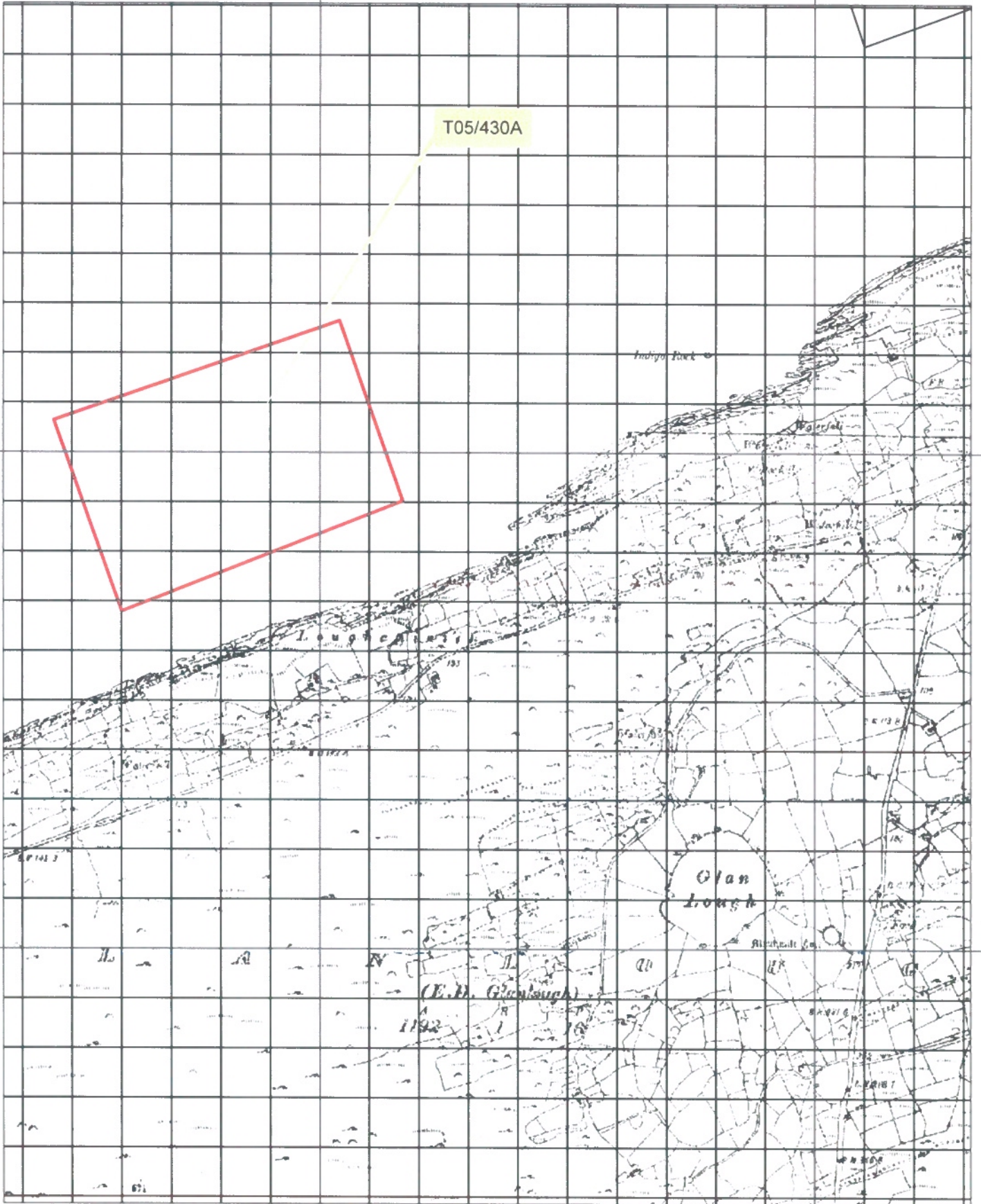





T05/430A



**Aqua Culture Sites**

<all other values>

**Site\_Status**

-  Under Appeal
-  Application
-  Lapsed
-  Licensed
-  Refused
-  Revoked
-  Sumendered
-  Withdrawn
-  100 Meter Reference Grid

1:10,560

Sites highlighted in red denotes Application

Ordnance Survey Ireland Licence No. EN 0076418  
© Ordnance Survey Ireland/Government of Ireland



**An Roinn Talmhaíochta,  
Bia agus Mara**  
Department of Agriculture,  
Food and the Marine